

# Internal services

## CHAPTER 8.1

This chapter gives guidance on meeting the Technical Requirements for internal services, including:

- the supply of hot and cold water
- plumbing
- gas
- electrical installations.

8.1.1	Compliance	01
8.1.2	Provision of information	01
8.1.3	Water services and supply	01
8.1.4	Cold water storage	03
8.1.5	Hot water service	03
8.1.6	Soil and waste systems	04
8.1.7	Electrical services and installations	05
8.1.8	Gas service installations	06
8.1.9	Meters	06
8.1.10	Space heating systems	07
8.1.11	Installation	07
8.1.12	Extract ducts	09
8.1.13	Testing and commissioning	10



### 8.1.1 Compliance

Also see: Chapter 2.1

**Internal services shall comply with the Technical Requirements and take account of service entries, ground hazards and chemical attack.**

Internal services which comply with the guidance in this chapter will generally be acceptable.

Adequate precautions against ground hazards and the entry of gas i.e. radon or gas, from landfill sites, should be provided as necessary. Further guidance can be found in BRE Report 211 'Radon: guidance on protective measures for new dwellings', and BRE Report 212 'Construction of new buildings on gas-contaminated land'.

### 8.1.2 Provision of information

**Designs and specifications shall be produced in a clearly understandable format, include all relevant information and be distributed to the appropriate personnel.**

Clear and fully detailed drawings should be available on site to enable work to be carried out in accordance with the design. Designs should be issued to site supervisors, relevant specialist subcontractors and suppliers, and include the following information:

- Location of sanitary fittings.
- Drainage runs.
- Location and size of water storage cisterns and cylinders.
- Hot and cold water pipe runs.
- Central heating pipe runs.
- Underfloor heating pipe runs.
- Gas supply pipe runs.
- Electrical outlets, switches and consumer units.

### 8.1.3 Water services and supply

Also see: water regulations and guides, BS EN 806

**Water services shall be based on the pressures and flow rates supplied from the incoming main. Components shall be selected and installed to ensure satisfactory service for the life of the system, with suitable precautions taken against corrosion and damage. Issues to be taken into account include:**

- a) suitability of materials and components
- b) adequate supply
- c) durability
- d) protection from the cold.

#### Suitability of materials and components

Relevant standards for materials and components used in domestic water systems include:

<b>BS EN 806</b>	'Specifications for installations inside buildings conveying water for human consumption'.
<b>BS 7206</b>	'Specification for unvented hot water storage units and packages'.
<b>BS EN 1057</b>	'Copper and copper alloys. Seamless, round copper tubes for water and gas in sanitary and heating applications'.
<b>BS 1566</b>	'Copper indirect cylinders for domestic purposes'.
<b>BS 3198</b>	'Specification for copper hot water storage combination units for domestic purpose'.
<b>BS 7291</b>	'Thermoplastics pipes and fittings systems for hot and cold water for domestic purposes and heating installations in buildings'.

#### Adequate supply

The design and installation of the water services supply should:

- be in accordance with building regulations, statutory requirements and the recommendations of the water supplier
- ensure drinking water is provided at the kitchen sink direct from the supply pipe or, where this is impracticable, from a storage cistern containing an adequate supply of drinking water
- be based on a minimum 1.5 bar dynamic pressure at the stop valve inside the home
- ensure a minimum 20L/min flow rate is available at the stop valve inside the home
- account for pressure and flow rate reductions (a wider supply pipe may be required inside the home)
- account for pressure fluctuations and surges, which may occur within the system and potentially damage fittings (surge arresters may be required)
- ensure that stop valves within the curtilage and outside the home are protected by a shaft or box
- ensure service pipes are a minimum of 750mm below the ground surface – where this is not possible, adequate precautions should be taken against frost and mechanical damage
- ensure that underground ducts are sealed at both ends to prevent the entry of fluids, vermin and insects
- be of materials which are safe and minimise the risk of corrosion
- be in accordance with the recommendations of the water supplier, including compatibility of the supply with the materials and fittings.

The water system should be capable of being drained (hot and cold services separately).

**Durability**

The hot and cold water service should be installed using corrosion resistant pipes and fittings.

In areas where pitting corrosion of copper cylinders occurs, it may be necessary to fit aluminium protector rods. These should be fitted during manufacture in accordance with the relevant British Standard. Sacrificial anodes should be installed where required by the water supplier.

**Protection from the cold**

To reduce the risk of freezing, water services should be located in the warm envelope of the home. Where they are located in unheated spaces, they should be insulated and not affected by cold. Insulation should be provided:

- around water services, including pipework (in accordance with Tables 1 and 2), cisterns and vent pipes (particular care is needed around bends and junctions, especially near openings to the outside air, such as eaves)
- as specified in the design (but not beneath a cold water tank)
- on each side of raised tanks in unheated roof spaces
- in accordance with BS 6700.

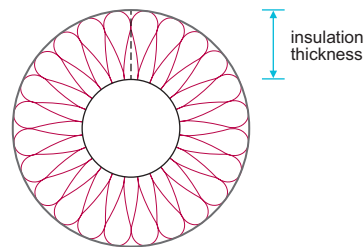
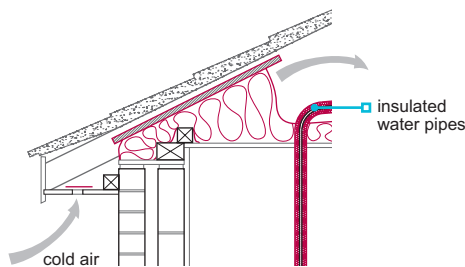

**Table 1:** Minimum insulation thickness to delay freezing inside domestic premises for cold water systems

Outside pipe diameter (mm)	Minimum insulation thickness (mm)			
	Thermal conductivity of material at 0°C W/(mK)			
	0.025	0.030	0.035	0.040
15	30	45	70	91
22-28	12	15	19	24

The conditions assumed for the table are:

- air temperature -6°C
- water temperature +7°C
- ice formation 50%.

**Table 2:** Examples of insulating materials:

Thermal conductivity W/(mK)	Material
Less than 0.020	Rigid phenolic foam.
0.020-0.025	Polyisocyanurate foam and rigid polyurethane foam.
0.025-0.030	PVC foam.
0.030-0.035	Expanded polystyrene, extruded polystyrene, cross-linked polyethylene foam, expanded nitrile rubber and improved polyethylene foam.
0.035-0.040	Standard polyethylene foam, expanded synthetic rubber and cellular glass.

Where the floor is of suspended construction, the underfloor water service should be insulated as it passes through the ground and the ventilated space.

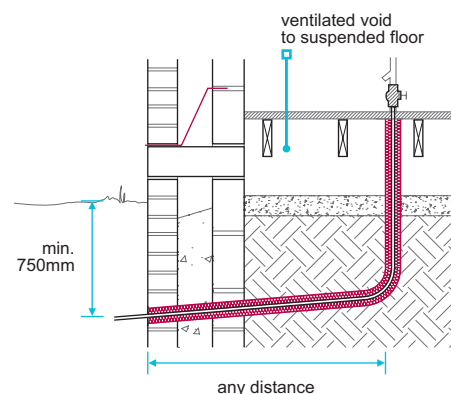

**8.1.4 Cold water storage**

**Cold water service shall be provided in accordance with statutory requirements and be adequate.**

Cold water storage should be provided with suitable capacity and include primary feed cisterns where indirect water heating systems are installed. Cold water storage should be provided:

- to supply an open vented hot water storage system (where required by the water supplier)
- to supply cold water outlets (where not connected to the mains supply).

Cisterns should:

- be accessible for inspection and maintenance
- be protected by a rigid close-fitting cover (non-airtight) that also excludes light and insects
- have holes neatly formed with a cutter in the positions shown in the design
- be suitably supported.

BS 6700 provides the following recommendations:

- Storage capacity for small homes – only cold water fittings – 100-150L.
- Storage capacity for small homes – supplying hot and cold outlets – 200-300L.
- Storage capacity for larger homes – 100L per bedroom.

Warning and overflow pipes:

- should be provided at each cold water cistern, to a suitable external discharge, unless permitted by water regulations where it may be internal if it is conspicuous
- should be adequately sized (19mm minimum)
- should be situated 25mm from the shut-off water level in the cistern
- may dip below the water level in accordance with water regulations, terminate vertically downwards or be fitted with a horizontal tee where it discharges.

The cistern bottom should be continuously supported by materials such as:

- softwood boarding
- marine plywood
- chipboard type P5 to BS EN 312
- oriented strand board type OSB3 to BS EN 300, laid with the stronger axis (as marked on board) at right angles to the bearers.

Access should:

- be provided to the main roof space and voids that contain cisterns and tanks, etc. (not required to roof spaces containing only water pipes)
- be via an opening (access hatch) with a minimum width of 520mm in each direction
- not be located directly over stairs or in other hazardous locations
- include a minimum 1m<sup>2</sup> platform located for maintenance purposes
- include securely fixed boarded walkways between the opening and the cistern or other permanent equipment (boarding should be securely fixed without compressing the insulation).

**8.1.5 Hot water service**

*Also see: BS 6700*

**Hot water service shall be provided in accordance with statutory requirements and be adequate for the demand and consumption.**

Hot water services should be designed in accordance with Table 3, and:

- the minimum flow rate should be in accordance with the statutory requirements and generally be available; it may be less where the pressure and flow rate of the incoming supply falls below 1.5 bar
- have the design flow rate available at each outlet when the total demand does not exceed 0.3L/s (where simultaneous discharge occurs, the flow rate at individual outlets should not be less than the minimum rate).

**Table 3:** Flow rate and temperature requirements

Outlet	Design flow rate L/s	Minimum flow rate L/s	Supply temperature °C
Bath (from storage)	0.3	0.2	60
Bath (from combi)	0.2	0.15	40
Shower (excluding instantaneous electric showers)	0.2	0.1	40
Wash basin	0.15	0.1	40
Sink	0.2	0.1	60

Hot water storage should comply with the minimum capacity in Table 4 (based on a draw-off temperature of 60°C), and where appliances require greater volumes, the capacity should be increased accordingly.

**Table 4:** Minimum storage requirements

Shower only	Bath only	Bath and shower(s) <sup>(1)</sup>	Two baths
60L	120L	145L	180L

Note

1 Maximum of two showers (excludes instantaneous electric showers).

Where systems are heated by off-peak electricity, the storage capacity should be in accordance with the recommendations of the electricity supplier.

Where homes have one bathroom or shower room, the system should be able to provide adequate hot water:

- immediately after the bath has been filled, for tasks such as washing
- for a second bath after 20 minutes.

Instantaneous systems (using combination boilers) produce hot water on demand (generally at lower flow rates than storage systems), and should only be used where:

- simultaneous demand for hot water is limited. Where there are three or more outlets, the design for simultaneous discharge can omit the outlet at the kitchen sink
- storage combination boilers have the capacity as required in Table 4.

Where homes have two or more bathrooms, the system should be able to provide adequate hot water immediately after each of the baths have been filled, for tasks such as washing.

Where a shower is installed, adequate provision should be made to ensure that the outlet temperature of the water is not significantly affected by the use of other hot or cold outlets in the home. This may be achieved by the provision of a thermostatic shower mixing valve, the appropriate design of pipe sizes or dedicated supplies.

Where boilers can control and prioritise hot water outputs:

- storage capacities can be less than the figures in Table 4
- the storage capacity should be in accordance with the manufacturer's recommendations.

Storage systems provide higher flow rates than instantaneous systems, and:

- require a suitable space for the siting of the storage vessel
- where vented, should be provided with an expansion pipe.

Unvented hot water storage systems should be:

- assessed in accordance with Technical Requirement R3, or meet the requirements of BS 7206 and be the subject of third-party certification, e.g. Kitemarking (applies to both the assembled system and components)
- installed by competent installers.

Hot water cylinders should be:

- supported in accordance with manufacturer's recommendations
- installed vertically, unless designed otherwise
- accessible for maintenance
- insulated as specified in the design.

Where an immersion heater is fitted, it should be:

- appropriate for the type of water supplied to the home
- controlled by a thermostat
- located to facilitate replacement
- fitted with an on/off switch.

### 8.1.6 Soil and waste systems

Also see: BS EN 752 and BS EN 12056

**Soil and waste systems shall be in accordance with relevant building regulations and installed to ensure that effluent is removed without affecting health or creating unnecessary noise and smell.**

Soil and waste systems should be:

- in accordance with the requirements of the water supplier
- adequately ventilated at the head of underground drains (this may be by a soil pipe or separate ventilation pipe)
- adequately ventilated at each branch
- arranged to ensure foul air from the drainage system cannot enter homes (e.g. ventilated to 900mm above openings when within 3m)
- fixed neatly and securely to provide the correct falls
- fitted to prevent the entry of vermin.

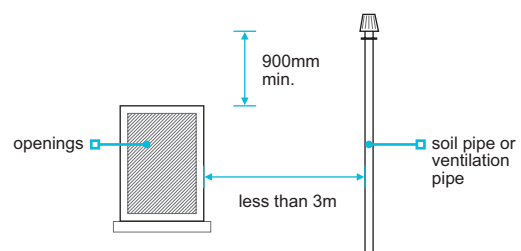

Air admittance valves should:

- be used to allow air to enter the drainage system (but do not avoid the need to ventilate it adequately)
- where used to terminate a soil pipe, comply with BS EN 12380 or be assessed in accordance with Technical Requirement R3
- not be positioned in areas which are liable to freezing
- have free movement of air around them which can be achieved by ventilation grilles, discreet gaps around the boxing or ventilation of the boxing into a ventilated roof void (the ventilation area should be 2500mm<sup>2</sup> minimum unless otherwise specified by the manufacturer)
- where positioned within the home, be accessible for maintenance.

Sound insulation should be provided to soil pipes passing through homes by:

- an encased boxing, using a minimum 15kg/m<sup>2</sup> board material
- wrapping the pipe with a minimum 25mm of unfaced mineral fibre (the insulation should be continued through the thickness of each sound-insulating floor).

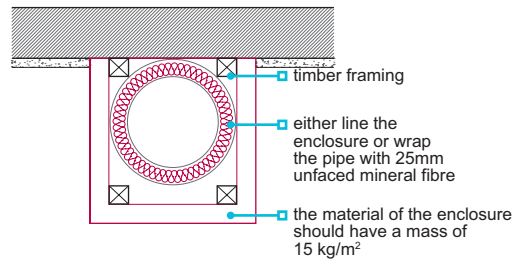

Sanitary fittings should be:

- installed with accessories, such as chains and plugs
- secured using non-ferrous or stainless steel screws or fixings appropriate to the weight of item being secured
- fitted without using excessive packing
- fitted to ensure WC lids and seats are stable when open.

Waste disposal units should be:

- provided with adequate support
- fitted with a tubular trap (not bottle or resealing)
- connected to the drainage system in accordance with the manufacturer's instructions.

The junctions of wall tiling with baths and showers should be made watertight using a flexible sealant to accommodate movement. The manufacturer's instructions should be followed.

### 8.1.7 Electrical services and installations

*Also see: BRE report 'Thermal insulation: avoiding risks'*

**Electrical installations shall be provided in accordance with relevant regulations, codes and standards. The installation shall ensure safe and satisfactory operation and be protected from chemical attack.**

Electrical services and installations should:

- comply with BS 7671 'Requirements for electrical installations'
- comply with BS 6004 'Electric cables. PVC insulated and PVC sheathed cables for voltages up to and including 300/500 V, for electric power and lighting'
- have fittings and components located in accordance with relevant building regulations
- be installed in accordance with the manufacturer's recommendations
- ensure cables are not placed under, against or within thermal insulation, unless they have been appropriately sized and derated
- ensure PVC covered cables are not in contact with polystyrene insulation.

Rooms should be provided with the minimum number of 13A outlets listed in Table 5 (dual outlets count as two).

**Table 5:** Minimum number of outlets

Room	Outlets	Notes
Kitchen/utility	8	Where homes have separate areas, the kitchen should have a minimum of four outlets and the utility room four. Where appliances are provided, a minimum of three outlets should be free for general use.
Living or family room	8	A minimum of two outlets near the TV aerial outlet.
Bedrooms	6 (4)	A minimum of six outlets for the main bedroom and a minimum of four outlets for other bedrooms.
Dining room	4	
Landing	2	
Hall	2	



Cables without special protection, such as an earthed metal conduit, should be positioned:

- vertically or horizontally from the outlet or switch being served
- within the shaded zone in the diagram, or
- a minimum of 50mm from the surface of a wall, or a minimum of 50mm from the top or bottom of a timber joist, or batten in a floor or ceiling.

Where the position of switches or sockets can be determined from the reverse side of the wall or partition, the zone on one side of the wall or partition applies to the reverse side.

### Lighting outlets

Lighting outlets should be provided:

- in each room, hall, landing and staircases
- with two-way switching at each floor level in a staircase

### Cooking spaces

Cooking spaces should:

- have a minimum 30A supply which is suitably switched and terminated
- have a 13A socket outlet where there is a gas supply

### Electrical supply to gas appliances

Where a gas appliance requires an electrical supply, a suitable fixed spur or socket outlet should be provided.

### TV

Aerials are not required; however, one of the following should be provided:

- a concealed, coaxial cable from the roof void to a terminal outlet in the main living room
- a conduit and draw wire or suitable alternative.

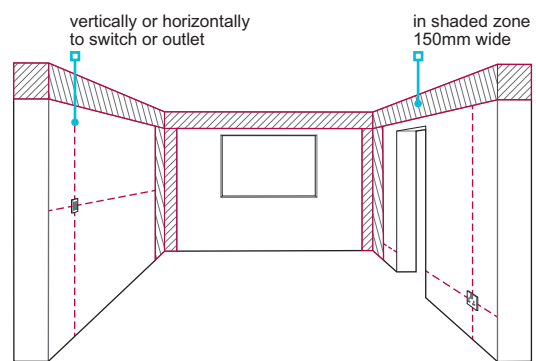

- in the common areas of homes and controlled by either manual switching or automatic light-sensitive controls.

- where provided, have cooker panels located to the side of the cooker space.

## 8.1.8 Gas service installations

Also see: Chapters 6.2, 6.8, BS 5482, BS 6400 and BS 6891

**Gas service installations shall be adequate and comply with the gas safety regulations, and be in accordance with relevant standards and codes to ensure safe and satisfactory operation.**

Gas service installations should ensure:

- service pipework up to and including the emergency control valve and meter is in accordance with the requirements of the gas transporter, gas supplier and primary meter owner
- installation of pipework and appliances complies with relevant standards and codes including those published by the Institution of Gas Engineers and Managers (IGEM) or Gas Safe Register (GSR)
- where there is a gas supply to the home, a gas point at the cooker space should be provided. This is not required where an electric hob is provided
- where gas pipework is to be installed in timber frame, allowance is made for differential movement.

## 8.1.9 Meters

Also see: Chapter 6.1

**Openings in walls for meter cabinets shall be structurally adequate and prevent dampness entering the home.**

Openings set into external walls should be provided with:

- DPCs and cavity trays
- lintels (except for purpose-designed built-in meter boxes).

Meters and associated equipment should be located to be reasonably accessible and not subject to damage.

Domestic meters may be of the following type:

- Built-in (to the outer leaf of the wall).
- Surface-mounted (on an external wall).
- Semi-concealed (sunk into the ground adjacent to the outer wall).
- Individually purpose-made compartments in accordance with the recommendations of BS 6400.

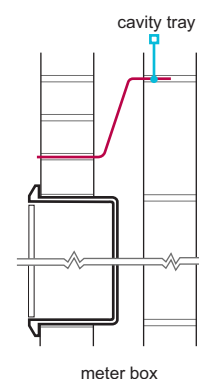

### 8.1.10 Space heating systems

Also see: Chapter 6.8

Where space heating is provided, it shall be in accordance with the relevant codes and standards, and ensure safe operation.

Where appropriate, space heating systems should comply with the following:

<b>BS 5410</b>	'Code of practice for oil firing'.
<b>BS EN 14336</b>	Heating systems in buildings. Installation and commissioning of water based heating systems.
<b>BS 8303</b>	'Installation of domestic heating and cooking appliances burning solid mineral fuels'.
<b>BS EN 12828</b>	'Heating systems in buildings. Design for water-based heating systems'.
<b>BSRIA guide BG 4/2011</b>	'Underfloor heating and cooling'.

Space heating appliances, including all components and controls, should be of a type approved by the relevant authority, including:

- Solid fuel – Solid Fuel Association, Heating Equipment Testing & Approval Scheme
- Electricity – British Electrotechnical Approvals Board
- Oil – OFTEC.

The provision of whole home or central heating is discretionary. Where provided, it should be designed in accordance with Table 6, recognised standards, and:

- the number of air changes per hour from kitchens and bathrooms should account for any mechanical ventilation
- where rooms contain open flued appliances, the rate of air change used for the design should be increased in accordance with BS EN 12828
- design temperatures should be verified by calculations and not by performance tests
- the main living room should have a heating appliance or a heat output as part of a whole home heating system
- temperature calculations should be based on a -3°C external temperature.

**Table 6:** Room temperatures and ventilation rates

Room	Room temperature °C	Ventilation rate (air changes per hour)
Living room	21	1.5
Dining room	21	1.5
Bedroom	18	1
Hall and landing	18	1.5
Kitchen	18	2
Bathroom	22	2
Toilet	18	2

### 8.1.11 Installation

Internal services shall not adversely affect the stability of the home and be installed to ensure satisfactory operation. Issues to be taken into account include:

- a) fitting of pipes and cables
- b) notching and drilling of joists
- c) concealed services.

#### Fitting of pipes and cables

Services should:

- comply with Chapter 5.1 'Substructure and ground-bearing floors' where they pass through the substructure
- be protected by a sleeve, or ducted, when passing through structural elements and not solidly embedded
- not be located in the cavity of an external wall, except for electricity meter tails
- not be buried in screeds unless permitted by relevant codes of practice.

Where copper pipes are permitted in floor screeds, they should be:

- sleeved or wrapped so that they can move freely along the length and at joints and bends
- jointed with capillary joints.

Pipes should:

- be adequately secured with suitable clips or brackets
- be installed neatly with clips spaced to prevent sagging, but not restrict thermal movement
- have adequate falls (where appropriate)
- be installed with adequate room for thermal expansion and contraction to avoid damage and noise.



Plastic pipework should be wrapped with metallic tape where it is in, or behind, wall surfaces, and would otherwise not be located by a metal detector or similar equipment.

Joints in pipes should be made:

- strictly in accordance with the manufacturer's instructions
- using lead-free flux recommended by the pipe manufacturer, with traces removed immediately after jointing.

Fire stopping should be provided around any services which penetrate fire-resisting floors, walls or partitions. Where a proprietary system, such as an intumescent seal is used, it should be installed in accordance with the manufacturer's instructions.

### Notching and drilling of joists

Notching, drilling and chasing to accommodate service pipes and cables should either:

- comply with the clauses below, or
- be designed by an engineer.

#### Solid timber and studs

**Table 7:** Limits for notching and drilling solid timber members

	Location	Maximum size
Notching joists up to 250mm in depth	Top edge 0.1-0.2 x span	0.15 x depth of joist
Drilling joists up to 250mm in depth	Centre line 0.25-0.4 x span	0.25 x depth of joist
Drilling studs	Centre line 0.25-0.4 x height	0.25 x depth of stud

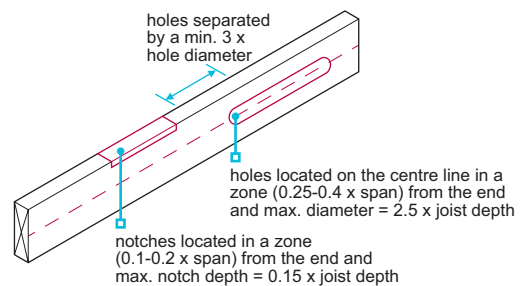
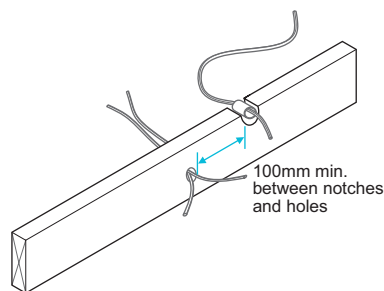

Where the structural strength is impaired by notching or drilling, the element should be replaced or correctly repaired.

Holes should be spaced at a minimum of three times the hole diameter.

Notches and holes in the same joist should be separated by a minimum horizontal distance of 100mm.

Instructions should be obtained from the designer when notching and drilling, where:

- the joist is deeper than 250mm, or
- it is close to heavy loads, such as those from partitions, cisterns, cylinders and stair trimming.
- the dimensions are not in accordance with Table 7, or

#### I-joists

Preformed holes are provided, and additional holes and notches should not be cut without the approval of the manufacturer.

#### Metal web joists

Services should run in the gaps between the metal webs. Conduits may need to be inserted before the joists are fixed in position.

#### Lightweight steel

Light weight steel should be used in accordance with Chapter 6.10 'Light steel framed walls and floors'.

#### Concealed services

Services concealed in walls or floors should be located so that significant cracking of the surface does not occur. Where chases in walls are necessary, their depth should not exceed:

- 1/6 thickness of the single leaf for horizontal chases
- 1/3 thickness for vertical chases.

Hollow blocks should not be chased unless specifically permitted by the manufacturer.

Pipes under floor screeds should:

- be protected by wrapping or ducting
- have adequate allowance for thermal expansion, particularly at changes of direction.

Screed cover should be a minimum of 25mm over pipes and insulating material, and:

- where pipes cross, it may be necessary to form a duct to achieve adequate cover

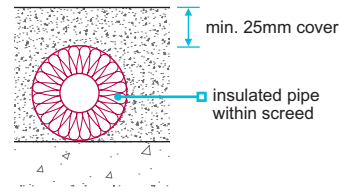

- for in-situ suspended concrete floors, the location and depth of pipes should be approved by the designer.

### 8.1.12 Extract ducts

Also see: Chapter 8.3

**Ductwork to intermittent and continuously running mechanical extract ventilation systems shall ensure satisfactory performance and durability. Issues to be taken into account include:**

- |                            |                 |
|----------------------------|-----------------|
| a) building integration    | d) installation |
| b) resistance to airflow   | e) terminals.   |
| c) control of condensation |                 |

#### Building integration

The route of ductwork should take account of other building elements. Ductwork passing through structural elements should not adversely affect the structural or fire performance of the building. Where alterations to structural elements, such as I-joists, are required, this should only be carried out in accordance with the manufacturer's recommendations, or be designed by an engineer in accordance with Technical Requirement R5.

The fire requirements of the building should be in accordance with relevant building regulations and standards. Issues that should be taken into account include:

- |   |   |
|---|---|
| ■ suitable detailing of components passing through other elements of the building | ■ the integrity of protected stairs and halls |
| ■ the location and type of dampers and firestops to be used                       | ■ the integrity of walls and floors.          |

#### Resistance to airflow

Ductwork systems should be designed to minimise the resistance to airflow, and be formed from compatible components.

Rigid duct is preferable to flexible, but where flexible duct is used, it should be restricted in length to ensure that the airflow resistance does not prevent the designed ventilation rate from being achieved. Flexible duct should be installed:

- |            |  |
|------------|--|
| ■ straight | ■ in accordance with the manufacturer's recommendations. |
|------------|--|

Bends should generally be formed with proprietary rigid components. Where flexible duct is used to form bends on an intermittent extract system, they should be restricted to a maximum of:

- |                                |   |
|--------------------------------|---|
| ■ two for systems up to 30 L/s | ■ one for extract rates higher than 30 L/s. |
|--------------------------------|---|

#### Control of condensation

Where extract ductwork passes through unheated spaces, it should be continuously insulated to achieve a thermal resistance equivalent to a minimum of 25mm of insulating material with a thermal conductivity of 0.04W/(mK). This can be achieved by using:

- |                                       |                                    |
|---------------------------------------|------------------------------------|
| ■ suitable pre-insulated ductwork, or | ■ a proprietary insulation system. |
|---------------------------------------|------------------------------------|

Alternatively, the ductwork can be fitted with a condensate trap that discharges to the outside or installing the duct to slope to the outside.

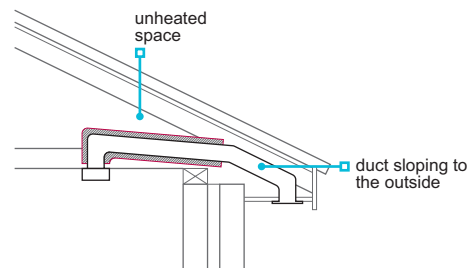
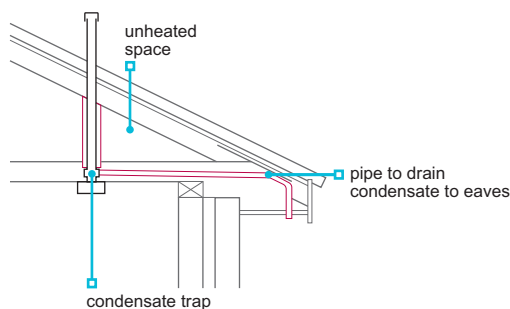

## Installation

Ductwork should be installed in a neat and workmanlike manner, be securely fixed, and have:

- adequate support throughout its length
- sealed mechanically fixed joints and connections.

Where ductwork passes through an external wall, it should be positioned to slope slightly outwards to prevent water entering the building. Clips and supports for ductwork should be spaced at equal distances and in accordance with the ductwork manufacturer's recommendations. For rigid ductwork, they should not generally be more than 750mm apart.

Ductwork should not be in direct contact with other surfaces, such as plasterboard ceilings, that may transfer noise to the home.

## Terminals

Ventilation systems should terminate freely to open air.

The air flow resistance of terminals should not adversely affect the performance of the ventilation system. Airflow resistance of terminals can be obtained through testing in accordance with BS EN 13141-2.

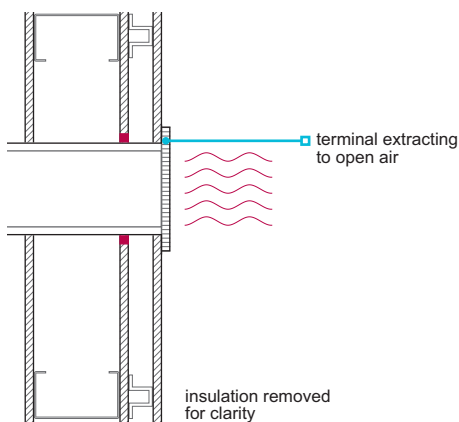

### 8.1.13 Testing and commissioning

**Services shall be tested and commissioned to ensure satisfactory operation.**

Services should be tested:

- in accordance with all relevant regulations and codes of practice.
- where pipes are located under screeds (including air or water testing before and after the screed is laid)
- to ensure leaks or other defects are made good prior to the application of finish and handover of the home.

Before completion and handover of the building services should be commissioned in accordance with relevant regulations and codes of practice.

# Low or zero carbon technologies

## CHAPTER 8.2

This chapter gives guidance on meeting the Technical Requirements for low or zero carbon (LZC) technologies.

8.2.1	Compliance	02
8.2.2	Provision of information	03
8.2.3	Clean Air Act	03
8.2.4	System design	03
8.2.5	Access	04
8.2.6	Handling, storage and protection	04
8.2.7	Sequence of work	04
8.2.8	Location	04
8.2.9	Building integration	04
8.2.10	Fixing	05
8.2.11	Electrical installation requirements	06
8.2.12	Pipes, insulation and protection from cold	06
8.2.13	Ground collectors	06
8.2.14	Fuel storage	07
8.2.15	Safe discharge	07
8.2.16	Testing and commissioning	07
8.2.17	Handover requirements	07
8.2.18	Further information	07



### Introduction

This chapter provides guidance on low or zero carbon (LZC) technologies acceptable to NHBC. Other systems that follow the general principles of this chapter may also be acceptable, subject to specific agreement with NHBC. Additional requirements for solid fuel and oil fired boilers are given in Chapter 6.8 'Fireplaces, chimneys and flues'. Guidance on other internal services is given in Chapter 8.1 'Internal services'.

This chapter provides guidance on the following technologies:

#### Biomass boiler

Systems which burn wood pellets or chips for space and/or water heating.

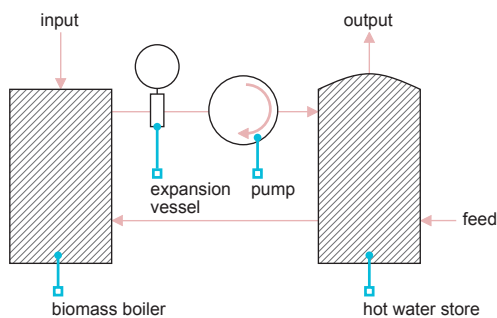

#### Heat pump

Systems which transfer heat from low energy sources. The most common sources are ground, outdoor air and exhaust air.

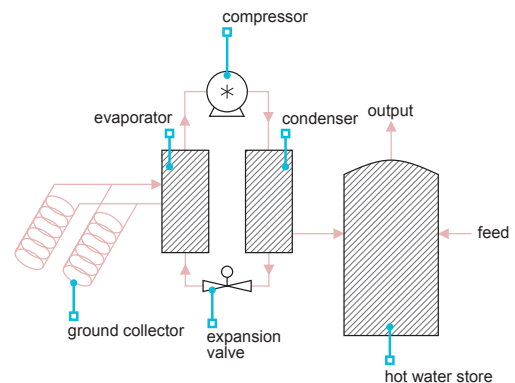

#### Solar photovoltaics (PV)

Systems which convert solar radiation into electricity.

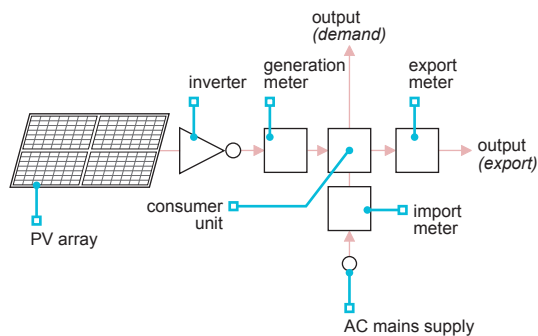

#### Solar thermal water heating

Systems which convert solar radiation energy to space and/or water heating.

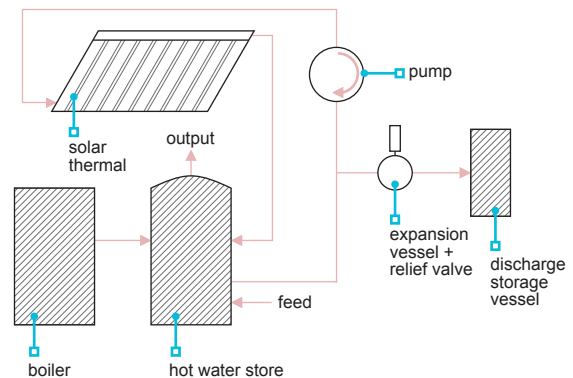

#### Wind turbine

Systems which convert wind energy into electricity.

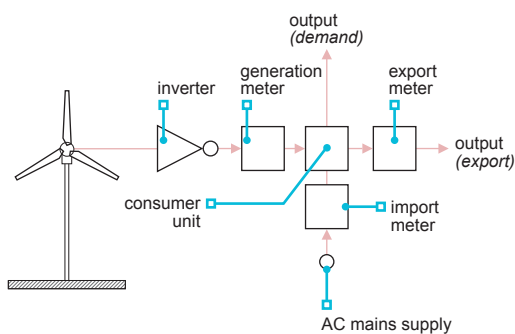

The illustrations provided within the introduction are generic and do not indicate the only possible systems acceptable to NHBC.

## Definitions for this chapter

<b>Controls</b>	Controls are used to operate and/or regulate the system and may be electrical or mechanical.
<b>Exclusion zone</b>	An area where entry is restricted during periods when maintenance is in progress, to prevent risk of injury or loss of life.
<b>Ground collectors</b>	The component of a ground source heat pump system which absorbs heat from the ground. Collectors can be installed either horizontally or vertically in the ground. They may also be incorporated into proprietary foundation systems.
<b>Interstitial condensation</b>	Condensation occurring within, or between, the layers of the building envelope.
<b>Inverter</b>	A device that converts direct current into alternating current.
<b>Islanding (island mode operation)</b>	Where an LZC technology feeds the network or local distribution system during a planned or unscheduled loss of mains supply.
<b>Low or zero carbon (LZC) technologies</b>	A term applied to renewable sources of energy, and also to technologies which are significantly more efficient than traditional solutions, or which emit less carbon in providing heating, cooling or power.
<b>Open loop system stem</b>	A heat pump system that extracts water from an underground source, pumps it through a heat exchanger and returns it underground.
<b>Parallel electrical generation</b>	A system in which building loads can be fed simultaneously from the national grid or electricity supply grid and on-site sources such as wind turbines and photovoltaic panels.
<b>Performance</b>	The manner or quality of functioning for a material, product or system.
<b>Refrigerant pipework</b>	Carries refrigerant between the indoor and outdoor unit of a split system. Normally made of copper and must be insulated and protected from damage.
<b>Renewable energy</b>	Energy from naturally available sources that can be replenished, including energy from the sun, the wind and tides, and from replaceable matter such as wood or other plant material.
<b>Split system</b>	A type of heat pump in which the condenser is located indoors, the evaporator is located outdoors, and the two are linked by refrigerant pipework.
<b>Switchgear</b>	The combination of electrical switches, fuses and/or circuit breakers used to isolate electrical equipment.

### 8.2.1 Compliance

Also see: Chapter 2.1 and [www.microgenerationcertification.org](http://www.microgenerationcertification.org)

**LZC technologies shall comply with the Technical Requirements. Issues to be taken into account include:**

- a) relevant standards
- b) product certification
- c) operative competency.

LZC technologies that comply with the guidance in this chapter will generally be acceptable.

#### Relevant standards

LZC should comply with relevant standards including where applicable:

<b>BS EN 12975-1</b>	'Thermal solar systems and components. Solar collectors'.
<b>BS EN 12976-1</b>	'Thermal solar systems and components. Factory made systems'.
<b>BS EN 61215</b>	'Crystalline silicon terrestrial photovoltaic (PV) modules'.
<b>BS EN 61646</b>	'Thin film terrestrial photovoltaic (PV) modules'.
<b>EN 14511</b>	Parts 1-4 'Air conditioners, liquid chilling packages and heat pumps with electrically driven compressors for space heating and cooling'.
<b>BS EN 61400-1</b>	'Wind turbines'.
<b>BS EN 61400-2</b>	'Wind turbines. Small wind turbines'.
<b>BS EN 14785</b>	'Residential space heating appliances fired by wood pellets'.
<b>BS EN 12809</b>	'Residential independent boilers fired by solid fuel'.
<b>BS EN 303-5</b>	'Heating boilers for solid fuels, hand and automatically fired, nominal heat output of up to 300kW. Terminology, requirements, testing and marking'.

### Product certification

LZC technologies should have current certification confirming satisfactory assessment by an appropriate independent authority acceptable to NHBC.

Systems, products and installations that are assessed through the Microgeneration Certification Scheme (MCS) will generally be acceptable to NHBC. Certification and test documentation should be made available to NHBC upon request.

Other certification bodies or test documentation may be acceptable where they are considered by NHBC to be a suitable alternative.

### Operative competency

LZC systems should be installed by operatives:

- competent and familiar with the system being installed, and
- certified to a standard acceptable to NHBC.

Installers who have been trained in accordance with the MCS installer standards will generally be acceptable to NHBC.

### 8.2.2 Provision of information

**Designs and specifications shall be produced in a clearly understandable format, include all relevant information and be distributed to all appropriate personnel.**

Design and specification information should be issued to site supervisors, relevant specialist subcontractors and suppliers, and include the following information:

- Indication of which manufacturer and/or installer is responsible for each system and interface.
- A full set of current drawings.
- Manufacturers' specifications.
- Fixing schedule.
- Interface details.
- Specification for controls.
- On-site testing requirements.
- Commissioning schedule.

### 8.2.3 Clean Air Act

**Biomass boilers installed in smoke controlled areas shall comply with relevant legislation.**

Biomass boilers to be installed within a smoke controlled area should comply with the Clean Air Act 1993 or Clean Air (Northern Ireland) Order 1981.

### 8.2.4 System design

**LZC technologies shall be designed to ensure satisfactory performance. Issues to be taken into account include:**

- a) location
- b) acoustics
- c) systems
- d) compatibility
- e) performance.

LZC technologies should be designed in accordance with the manufacturer's recommendations, certification scheme requirements and appropriate standards.

#### Location

The design and location of LZC technologies should take account of factors such as orientation, roof pitch and shading.

For stand-alone wind turbine systems, suitable exclusion zones should be provided in accordance with the manufacturer's recommendations and geographical location.

#### Acoustics

Design and location should take account of:

- internal and external noise
- vibration
- the effect on neighbouring properties, particularly the positioning of the LZC technology in relation to openings.



## Systems

Each system should generally be supplied from one manufacturer as a package and not as individual components or materials. However, where components from more than one manufacturer are used, they should be compatible to ensure satisfactory performance.

## Compatibility

LZC technologies should be installed so as not to adversely affect the performance of the building to which they are fixed, and in accordance with the manufacturer's recommendations.

Multiple systems should be compatible with each other.

## Performance

LZC technologies designed to contribute towards space and water heating should be designed in accordance with the performance requirements in Chapter 8.1 'Internal services'.

### 8.2.5 Access

**Appropriate arrangements shall be provided for the purposes of cleaning, inspection, maintenance and repair of LZC technologies.**

Safe access should be provided to the LZC technologies, including switchgear, inverters, meters and controls. This is to enable the cleaning, inspection, maintenance and repair of systems. Access should be provided in accordance with the manufacturer's recommendations.

### 8.2.6 Handling, storage and protection

**Materials, products and systems shall be handled, stored and protected in a satisfactory manner to prevent damage, distortion, weathering and degradation.**

LZC technologies should be:

- transported, lifted, handled and stored in accordance with the manufacturer's recommendations
- delivered in sequence to avoid storage
- protected to avoid the risk of damage.

### 8.2.7 Sequence of work

**LZC technologies shall be installed in accordance with a suitable schedule.**

To ensure performance, certain LZC systems and ancillary components should be installed in a logical and timely sequence in accordance with the manufacturer's recommendations.

### 8.2.8 Location

**LZC technologies shall be correctly located.**

LZC technologies, including ancillary components should be located and identified in accordance with the manufacturer's recommendations.

### 8.2.9 Building integration

**LZC technologies shall be securely fixed and not adversely affect the weather resistance of the building.**

Foundations and anchor points for stand-alone LZC technologies should be designed by an engineer in accordance with Technical Requirement R5 to withstand the structural forces acting upon them.

The structure to which the LZC technology is attached should be assessed according to its ability to accept the loadings and prevent detrimental effects arising from movement or vibration. The design of the structure should take account of:

- the self-weight of the LZC components
- snow loads
- imposed loads
- dynamic loading (where relevant).
- wind loads

Notching, drilling or chasing of structural components to accommodate service pipes or cables should either comply with Chapter 8.1 'Internal services', or be designed by an engineer in accordance with Technical Requirement R5.

Fixings, supports, bracketry and mounting frames should:

- accommodate all static and dynamic loads in accordance with the manufacturer's recommendations
- be designed to take account of ventilation and drainage requirements of the LZC technology
- have adequate protection against corrosion.

Where two metals are to be joined, they should either be compatible or isolated, to prevent bimetallic corrosion. Aluminium and aluminium alloys should not come into contact with cementitious material.

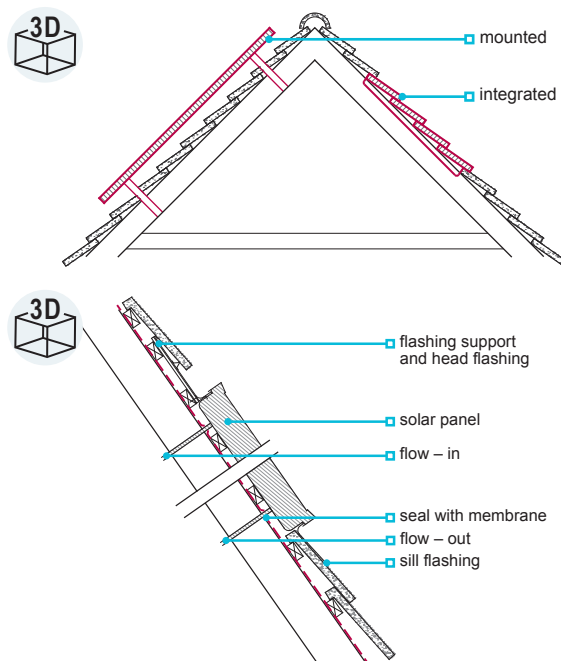

All interfaces between the LZC technology and the building should ensure adequate weather resistance, sealed to limit air leakage and prevent moisture from reaching the interior or any part of the structure that could be adversely affected by its presence. The envelope should be weatherproofed using appropriate flashings and fixings. Weatherproofing details that rely solely on sealant are not acceptable. Flashings should be formed from the materials listed in Table 1.

**Table 1:** Materials for flashings

Flashing material	Guidance
Rolled lead sheet	Minimum code 4. BS EN 12588.
Aluminium and aluminium alloys	BS EN 485 and BS EN 573, 0.6-0.9mm thick and protected from contact with mortar by a coating of bituminous paint.
Zinc alloys	BS EN 988 and 0.6mm thick.
Copper	BS EN 1172 0.55mm thick and fully annealed. Where two metals are to be joined, they should be compatible and not cause bimetallic corrosion in that environment. Alternatively, they should be isolated from each other.
Proprietary flashing, including plastic and composite.	Assessed in accordance with Technical Requirement R3.

To avoid potential surface or interstitial condensation, the design should take account of thermal bridging, particularly where any part of the system, including fixings, penetrates the thermal envelope.

### 8.2.10 Fixing

*Also see: Chapter 2.1*

**LZC technologies shall be fixed using durable materials.**

Fixings should comply with the types listed in Table 2.

**Table 2:** Materials suitable for fixings

Fixing material	Guidance
Phosphor bronze	NA
Silicon bronze	NA
Stainless steel	BS EN ISO 3506
Mild steel	Coatings to BS EN 12329, BS EN ISO 2082, BS EN 1461, or other appropriate treatment in accordance with BS EN ISO 12944 or BS EN ISO 14713.
Aluminium alloy	BS EN 573 and BS EN 755
Stainless steel	BS EN 10088
Mild steel	BS EN 10346
Other materials	Assessed in accordance with Technical Requirement R3.

Materials that comply with recognised standards, which provide equal or better performance to those above, are also acceptable.

The type, size, number, position and fitting tolerance of fixings should be in accordance with the manufacturer's recommendations. Issues that should be taken into account include:

- the provision of suitable locking nuts and washers
- the isolation of aluminium from cementitious material.
- the isolation of dissimilar metals

### 8.2.11 Electrical installation requirements

**The electrical installation shall be in accordance with relevant regulations.**

Electrical installations should comply with BS 7671 'Requirements for Electrical Installations'.

Where parallel electrical generation occurs, inverters should have a current Engineering Recommendation G83/1 type test certificate and comply with all other parts of ER G83/1 for standard installations. Larger installations should comply with ER G59/2.

The electrical installation should be capable of being isolated from all other electrical sources when required, for maintenance or testing.

LZC technologies which generate electricity and are connected to the mains should automatically disconnect when there is a mains power failure. This is to prevent them from feeding the network or local distribution system during a planned or unscheduled loss of mains supply. This is known as 'islanding'.

### 8.2.12 Pipes, insulation and protection from cold

**All pipework and insulation, including refrigerant pipework, shall ensure adequate performance and be designed to prevent freezing.**

Materials used for pipes and insulation should be suitable for the intended purpose and provide satisfactory performance for the life of the system. Pipes should comply with relevant codes and standards or be independently assessed for their intended use in accordance with Technical Requirement R3. Insulation materials should be inert, and durable, and should not be adversely affected by moisture or vapour. They should also comply with relevant codes and standards or be independently assessed for their intended use in accordance with Technical Requirement R3.

Where there is a risk of pipes freezing, they should be insulated, particularly when at, or close to, ground level.

Refrigerant pipework connecting split systems should be of refrigerant quality copper pipe or other material as recommended by the manufacturer. The pipe should be insulated, and the insulation should incorporate a vapour control layer to prevent ice build-up.

Air source systems should incorporate an automatic defrost cycle and suitable condensate drainage.

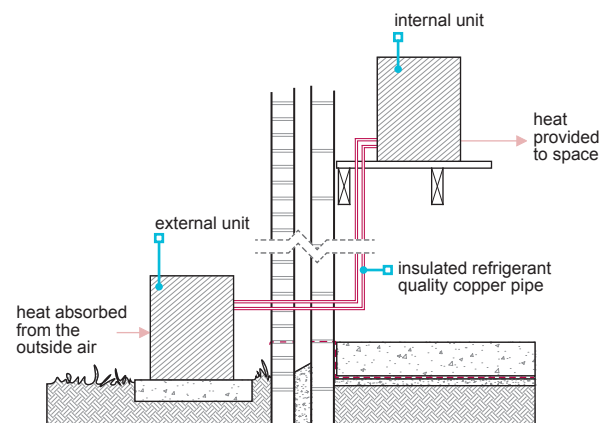

### 8.2.13 Ground collectors

**The installation of ground collectors shall take structural and environmental factors into account.**

The depth and layout of ground collectors should be specified to avoid freezing of adjacent ground. Where open loop systems are proposed, consultation with the appropriate environment agency should be made and may require one or more of the following:

- A licence to investigate groundwater.
- A discharge consent.
- An abstraction licence.

Excavations for the installation of ground collectors should not adversely affect aquifers, foundations, drainage, water supply pipes and other services. Design should take account of local planning authority guidance, including excavations that are close to trees and hedgerows.

Ground collectors should be protected and tested prior to backfilling.

### 8.2.14 Fuel storage

Also see: *The HVCA Guide to Good Practice Installation of Biofuel Heating (TR/38)*

#### Fuel storage for biomass boilers shall be suitable for the installation.

Fuel stores should have appropriate:

- access for delivery
- fire detection and extinguishing equipment where elevated dust levels are expected
- volume to take account of peak load and period of demand
- fire resistance and separation to prevent fire and gases entering other parts of the building.

### 8.2.15 Safe discharge

#### Discharge from LZC technologies shall terminate safely.

Solar thermal water heating systems should discharge into a storage vessel. The discharge pipework and vessel should be suitable to withstand high temperatures.

### 8.2.16 Testing and commissioning

#### LZC technologies shall be tested and commissioned in accordance with the commissioning schedule.

The installer should check that the system is in accordance with the certification requirements, the manufacturer's recommendations and the design. Issues to be taken into account include:

- the safety of the system
- the correct installation of the system
- the correct operation of the system.

Upon completion, the installer should provide a certificate to confirm that the LZC technology has been installed, tested and commissioned in accordance with the above.

### 8.2.17 Handover requirements

#### Detailed information and instructions shall be provided to the homeowner.

The pack of information provided to the homeowner should include:

- user instructions for the systems installed
- contact details for the manufacturer and installer
- key components installed
- a completed manufacturer's certificate from an acceptable independent assessment organisation, MCS or suitable alternative
- a completed installer's certificate from an acceptable independent assessment organisation, MCS or suitable alternative
- details of the fuel type and source
- maintenance and servicing requirements
- warranties and/or guarantees for the LZC technology.

### 8.2.18 Further information

- *BRE Digest 489*
- *BRE Digest 495*
- *British Wind Energy Association*
- *BS EN 12975-2: 2006*
- *BS EN ISO 14713: Part 1-4*
- *CE72*
- *CE131*
- *ER G59/2*
- *ER G83/1*
- *Photovoltaics in buildings.*

# Mechanical ventilation with heat recovery

## CHAPTER 8.3

This chapter gives guidance on meeting the Technical Requirements for mechanical ventilation with heat recovery (MVHR) systems acceptable to NHBC.

8.3.1	Compliance	01
8.3.2	Provision of information	01
8.3.3	Building integration	01
8.3.4	Noise	02
8.3.5	Design considerations	02
8.3.6	Access and operation	04
8.3.7	Ductwork	04
8.3.8	Fixing and jointing of ductwork	04
8.3.9	Commissioning and balancing	05
8.3.10	Handover requirements	05



### Definitions for this chapter

<b>Air valve (extract and supply)</b>	Wall or ceiling mounted fittings used to balance the flow rate of air between rooms; may be referred to as grilles.
<b>Exhaust ductwork</b>	Carries air from the fan unit and exhausts it to the external atmosphere.
<b>Intake ductwork</b>	Carries air from the external atmosphere to the MVHR fan unit.
<b>MVHR fan unit</b>	Unit that contains the fan(s), heat exchanger and filter(s).
<b>Service ductwork extract and supply</b>	Carries air between the air valves and the MVHR fan unit.
<b>Terminal fittings</b>	Located on the outside of the building to finish the intake and exhaust ductwork.

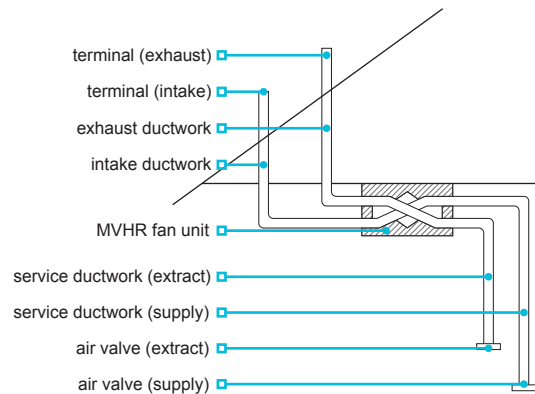

#### 8.3.1 Compliance

*Also see: Chapter 2.1, Approved Document F, Domestic Ventilation Compliance Guide, Section 3 of the Technical Handbooks, Domestic Ventilation Guide in Scotland and Technical Booklets in Northern Ireland*

**MVHR design, materials and sitework shall comply with the Technical Requirements, and be installed by competent operatives.**

MVHR systems that comply with the guidance in this chapter and are in accordance with the relevant British Standards and building regulations will generally be acceptable.

MVHR systems should be installed by operatives:

- competent and familiar with the system being installed, and
- trained in accordance with the BPEC installer scheme, or other suitable scheme acceptable to NHBC.

#### 8.3.2 Provision of information

**Designs and specifications shall be produced in a clearly understandable format, include all relevant information and be distributed to the appropriate personnel.**

Designs and specifications should be issued to site supervisors, relevant specialist subcontractors and suppliers, and include the following information:

- Location of all ductwork runs, the fan unit and controls.
- Type and location of ancillary components, including those used for fire safety and acoustic purposes.
- Type, size and position of ducts and terminals.
- Designed airflow-balancing figures for the system.
- Direction of fall for 'horizontal' ductwork.
- Type and spacing of clips and fixings.

#### 8.3.3 Building integration

*Also see: Chapter 7.1 and 7.2*

**MVHR systems shall ensure compatibility with other building elements and not adversely affect the performance of the building. Issues to be taken into account include:**

- a) weathertightness
- b) fixing of fan units
- c) firestopping.

##### Weathertightness

Proprietary roof terminals should be used to ensure the weathertightness of the roof covering.

##### Fixing of fan units

MVHR fan units should only be fixed to parts of the building capable of taking the load. Where MVHR fan units are supported by framed structures, additional components such as noggings may be required to provide a secure fixing point.

Fan units should be located, orientated and fixed in accordance with the design, using the clips, brackets and fixings recommended by the manufacturer.

### Firestopping

The MVHR system should not adversely affect the fire performance of the building. Issues to be taken into account include:

- ensuring that the fire requirements of the building are in accordance with relevant building regulations
- suitable detailing of components passing through other elements of the building
- location and type of firestops to be used
- integrity of protected stairs and halls
- integrity of walls and floors.

Proprietary fire components should be suitably tested, and specified to take account of the test conditions.

Relevant standards include:

<b>BS 476</b>	'Fire tests on building materials and structures.'
<b>BS EN 1365-2</b>	'Fire resistance tests for loadbearing elements. Floors and roofs.'
<b>BS EN 1366-3</b>	'Fire resistance tests for service installations. Penetration seals.'

### 8.3.4 Noise

**MVHR systems shall be designed to minimise disturbance caused by noise.**

MVHR fan units should be sized to run at their optimum speed and to provide suitable performance whilst taking the resulting noise and vibration into account. Specifying MVHR fan units that can provide the required airflow rates when running at less than full speed can reduce unnecessary noise.

Ductwork should be sized to allow air to pass freely without causing excessive noise disturbance. To reduce noise transfer along ductwork, a short length of flexible duct can be installed adjacent to air valves and fan units. Other issues to be taken into account include:

- noise between habitable rooms
- external noise
- location of the MVHR fan unit
- the type of mountings used to secure the MVHR fan unit.

### 8.3.5 Design considerations

*Also see: Chapter 9.1*

**MVHR systems shall ensure compatibility and satisfactory performance. Issues to be taken into account include:**

- a) performance
- b) systemised approach
- c) type and position of air valves and terminals
- d) control of condensation
- e) protection from cold.

### Performance

The MVHR system should be designed to provide satisfactory performance and be installed according to the design and manufacturer's recommendations. Variations from the design should maintain the satisfactory performance of the system and be approved by the designer.

Issues that should be taken into account include:

- ventilation rates as set out in appropriate building regulations and standards
- fan capacity, accounting for airflow resistance of the system
- ensuring the even distribution of airflow, taking into account airflow resistance, including from bends and fittings.

Airflow resistance should be calculated using figures for air valves and terminals determined in accordance with BS EN 13141-2 and data supplied by the duct manufacturer. Ductwork should be as direct as possible to reduce the number of bends.

Allowance should be made for air transfer within the home. Where gaps between the underside of internal doors and the floor finish are used for air transfer, the guidance in Chapter 9.1 'A consistent approach to finishes' should be considered.

### Systemised approach

The MVHR system should be designed as a complete package, taking into account the performance of all components and materials, to ensure compatibility and the performance requirements of the system.

Particular consideration should be given where components from different manufacturers are specified on the same system.



### Type and position of air valves and terminals

Air valves should be selected according to location and function, ensuring appropriate specification for:

- wall or ceiling location
- supply or extract function
- the velocity of the system.

To create cross-ventilation within a room and to ensure satisfactory operation, air valves on low velocity systems should be:

- positioned on the opposite side of the room from internal door openings
- a minimum of 200mm from walls, where located on a ceiling
- a maximum of 400mm from the ceiling, where located on a wall
- a minimum of 600mm (on plan) from hobs in kitchens
- positioned to account for the likely location of tall furniture and to avoid draughts over beds and seating areas
- lockable, where adjustable.

To prevent cross-contamination, intake terminals should generally be separated from exhaust terminals and other potential sources of pollution by a minimum of 1m measured on plan. Increased separation distances may be required between the intake and any:

- soil and vent pipe terminal
- boiler flue outlet
- biomass or solid fuel chimney terminal.

Terminals should prevent the entry of birds and animals.

### Control of condensation

Ductwork should be insulated to prevent condensation formation where:

- it passes through spaces outside the insulated parts of the home, such as a roof void
- carrying cold air through spaces that are within the insulated parts of the home.

This can be achieved by using suitable pre-insulated ductwork, or a proprietary insulation system with a thermal resistance equivalent to a minimum of 25mm of insulating material, with a thermal conductivity of 0.04W/Mk.

Ductwork insulation, including that used for proprietary duct insulation systems and pre-insulated ducts should be:

- inert, durable and suitable for use with the ductwork system
- continuous and vapour resistant
- not adversely affected by moisture vapour
- installed in a neat and workmanlike manner to ensure that there are no gaps
- installed in accordance with the manufacturer's recommendations.

Where a vapour control layer is incorporated, the joints should be sealed using appropriate tapes or sealants as recommended by the manufacturer.

**Table 1:** Ductwork insulation

Type of duct	Ductwork continuously insulated	
	Ductwork located inside the insulated part of the home	Ductwork located outside the insulated part of the home
Intake	Yes	Yes
Exhaust	Yes	Yes
Service (supply and extract)	No	Yes <sup>(1)</sup>

Notes

<sup>1</sup> Additional insulation should be provided to protect the system from the cold.

Any condensate that forms within the fan unit or ductwork should be able to drain to a suitable outfall. Fan units should be located to enable connection of the condensate drain to the soil and waste system via a dry trap.

### Protection from cold

MVHR systems should be protected from the effects of cold. Issues to be taken into account include:

- performance in relation to indoor air quality
- the manufacturer's recommendations where any parts are located outside the insulated part of the home
- insulation of ductwork and other system components.

To prevent damage to the components and ensure satisfactory operation, MVHR systems should be fitted with automatic frost protection.

Horizontal sections of service ductwork, outside the insulated parts of the home, should be insulated to achieve a thermal resistance equivalent to at least 150mm of insulating material with a thermal conductivity of 0.04W/Mk. This may be achieved by installing the ductwork between the layers of horizontal insulation.

Condensate drains located outside the insulated part of the home should be insulated to prevent freezing.

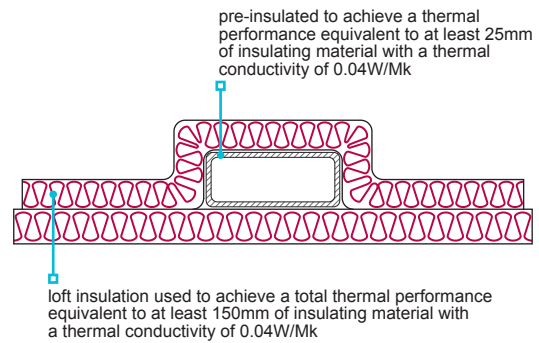

### 8.3.6 Access and operation

**MVHR systems shall be designed and installed to ensure that the fan unit and associated controls are easily accessible.**

**Table 2:** Guidance for the suitable functioning of, and access to, the MVHR system

	Fan unit located inside the insulated part of the home	Fan unit located outside the insulated part of the home
Access	Access should not be obstructed and panels should be located and sized to enable routine servicing to be carried out.	A safe means of access, including a suitable walkway and a working platform 1m <sup>2</sup> immediately adjacent to the MVHR fan unit, should be provided. The walkway and platform should be designed to ensure the continuity of any insulation, and the supporting structure should be designed to take account of the additional load.
Control and functionality	Where a 'boost' function is provided, it should switch off automatically and be located in, or adjacent to, the room it serves. Where a 'summer bypass' function is provided, it should operate automatically and divert the airflow around the heat exchanger. The MVHR system should be capable of being isolated by a switched fused spur.	
Indication and controls	MVHR systems should include visual indicators showing maintenance and servicing requirements, and mode of operation. These should be visible from within the insulated envelope, not obscured from view, and be simple to use.	
Cleaning	To maintain operating performance, extract service ductwork and air valves should either be fitted with filters, or ductwork should be accessible for cleaning.	

### 8.3.7 Ductwork

**Ductwork design and the materials used should be suitable for the intended purpose and not adversely affect the performance of the building.**

Ductwork should:

- provide satisfactory performance for the life of the system
- be routed as directly as practicable
- be of a rigid or semi-rigid material suitable for use in MVHR systems
- be fixed in accordance with the manufacturer's recommendations.

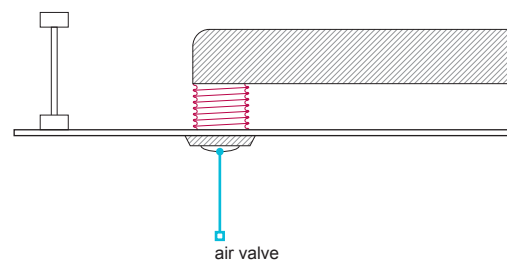

Bends, connections and junctions should be formed using proprietary components that are part of the ductwork system.

Flexible ducting should:

- only be located adjacent to fan units or air valves
- not be used to form bends.
- not be more than 300mm in length

Where ductwork routes require alterations to structural elements, these should be in accordance with the manufacturer's recommendations or in accordance with Technical Requirement R5.

### 8.3.8 Fixing and jointing of ductwork

**MVHR ductwork and insulation shall be installed to a satisfactory standard. Issues to be taken into account include:**

- a) fixing
- b) jointing.

Ductwork should be securely installed in a neat and workmanlike manner.

### Fixing

Parallel ductwork runs should be positioned to maintain a reasonably even gap.

To prevent condensate collecting, horizontal ductwork should be to a suitable outfall in accordance with the design, and installed to a true line to avoid localised dips.

Where ductwork passes through an external wall, it should be positioned to slope slightly outwards to prevent water entering the building.

Ductwork should be securely held in position by evenly spaced clips no more than 750mm apart, or in accordance with the ductwork manufacturer's recommendations.

Ductwork should not be in direct contact with other surfaces, such as plasterboard ceilings, that may transfer noise to the home.

### Jointing

The method and materials used for jointing ductwork should be specified by the duct manufacturer, and be:

- durable and airtight
- securely fixed
- sealed with purpose-designed connections in accordance with the manufacturer's recommendations.

Where tapes and sealants are used, they should be suitable for the intended purpose and be recommended by the ductwork manufacturer. Issues to be taken into account in relation to the durability of the jointing method include:

- thermal movement
- moisture
- temperature
- compatibility with the duct material.

Tape should be installed in a neat and workmanlike manner, and surfaces should be dry and free from grease and dust before applying. Excess sealant should not extrude to the inside of the duct.

### 8.3.9 Commissioning and balancing

**MVHR design, materials and sitework shall be tested and commissioned in accordance with the commissioning schedule.**

Upon completion of the installation MVHR systems should be protected from dust during the construction of the home. Where possible the system should be switched off and dust covers applied to air valves.

Prior to completion of the home, the system:

- including ductwork and filters, should be checked to ensure it is clear from dirt and dust that may have accumulated during construction
- should be commissioned to confirm performance
- should be adjusted by using the air valves and controls to achieve the correct balancing and airflow rates
- should have air valves locked in position after correct commissioning and balancing.

Where the system cannot be balanced using the air valves and system controls, the complete system should be checked to ensure that it complies with the design.

Any changes from the design should be referred back to the designer. Adjusting the fan speed above the designed output may result in noise disturbance, and should be avoided.

A copy of the commissioning certificate should be made available to NHBC upon request.

### 8.3.10 Handover requirements

**MVHR systems shall be provided with clear and detailed information and instructions that are handed over to the end user.**

The pack of information should be in a format intended for a non-technical user and include:

- the commissioning certificate
- user instructions for the system and its controls
- user-friendly description and explanation of the system, including the location of components
- details of routine maintenance, e.g. changing/cleaning the filters
- method of cleaning the ductwork, where required
- guidance for the use of summer bypass and boost settings, where installed
- contact details of the manufacturer and installer
- details of the installed system, including part numbers for consumables
- details of any maintenance and servicing agreements.

## Technical Disclaimer

The NHBC Standards are produced by NHBC as guidance solely for our builder customers as to how to interpret the technical requirements in relation to the warranty cover provided by NHBC under its Buildmark, Buildmark Choice, Buildmark Link, Buildmark Solo, Buildmark Connect or any similar product from time to time. It has not been created or intended for distribution or use outside of that purpose. The information contained in the NHBC Standards do not constitute advice and is not to be relied upon by any third party. Nothing in the NHBC Standards is intended to, nor should it be taken to, create any legal or contractual relationship. Any third party who chooses to rely upon the information contained in the NHBC Standards shall do so entirely at their own risk and NHBC accepts no duty of care or liability, however caused, in connection with its use or reliance by any third party.

NHBC is authorised by the Prudential Regulation Authority and regulated by the Financial Conduct Authority and the Prudential Regulation Authority.

NHBC is registered in England under company number 00320784. NHBC's registered address is NHBC House, Davy Avenue, Knowlhill, Milton Keynes, Bucks MK5 8FP.

NHBC Standards 2018 have been printed on material which is produced from sustainable forests and is fully recyclable and biodegradable, ECF (elemental chlorine free) and is made to ISO 14001 Environmental Certification.



NHBC, NHBC House,  
Davy Avenue, Knowlhill,  
Milton Keynes,  
Bucks MK5 8FP  
Tel: 0344 633 1000  
Fax: 01908 747255  
[www.nhbc.co.uk](http://www.nhbc.co.uk)

