

# Concrete and its reinforcement

## CHAPTER 3.1

This chapter gives guidance on meeting the Technical Requirements for concrete and its reinforcement.

3.1.1	Compliance	01
3.1.2	Provision of information	01
3.1.3	Storage of materials	01
3.1.4	Site-mixed concrete	01
3.1.5	Ready-mixed concrete	03
3.1.6	Concrete specification	03
3.1.7	Admixtures	06
3.1.8	Special types of concrete	07
3.1.9	Design of reinforced concrete	07
3.1.10	Installation of reinforcement	08
3.1.11	Blinding concrete	09
3.1.12	Formwork	09
3.1.13	Before concreting	09
3.1.14	Casting	09
3.1.15	Curing	10
3.1.16	Testing	10
3.1.17	Glossary	11



### Introduction

Concrete design and specification should comply with the relevant British Standards. Mix design should take account of strength and durability, and follow recognised standards and practices. Alternatively, mixes in accordance with the guidance in this chapter will be acceptable. This applies to plain and reinforced concrete, whether precast or in-situ.

#### 3.1.1 Compliance

*Also see: Chapter 2.1, BS 8500 and BS EN 206*

**Concrete and its reinforcement shall comply with the Technical Requirements.**

Concrete and its reinforcement that complies with the guidance in this chapter, which covers plain and reinforced concrete, precast or in-situ, will generally be acceptable.

Mix design should take account of strength and durability, and comply with the relevant British Standards.

#### 3.1.2 Provision of information

**Designs and specifications shall be produced in a clearly understandable format, include all relevant information and be distributed to appropriate personnel.**

Design and specification information should be issued to site supervisors, relevant specialist subcontractors and suppliers, and include the following information:

<b>Ground aggressivity</b>	<ul style="list-style-type: none"> <li>■ Design sulfate class (DS class).</li> </ul>	<ul style="list-style-type: none"> <li>■ Aggressive chemical environment for concrete class (ACEC Class).</li> </ul>
<b>Strength and durability</b>	<ul style="list-style-type: none"> <li>■ Strength.</li> <li>■ Maximum free water/cement ratio and/or minimum cement content.</li> <li>■ Consistence class (e.g. slump).</li> </ul>	<ul style="list-style-type: none"> <li>■ Air content (where required).</li> <li>■ Aggregate size.</li> <li>■ Colour.</li> </ul>
<b>Mix design and additional protective measures (APM)</b>	<ul style="list-style-type: none"> <li>■ Specification of mix designs (concrete strength class).</li> </ul>	<ul style="list-style-type: none"> <li>■ Details of any Additional Protective Measures.</li> </ul>
<b>Reinforcement and movement joints</b>	<ul style="list-style-type: none"> <li>■ Cover to reinforcement.</li> <li>■ Reinforcement, plans, sections and bending schedules.</li> <li>■ Reinforcement details at supporting edges.</li> <li>■ Camber in beams and slabs, where appropriate.</li> </ul>	<ul style="list-style-type: none"> <li>■ Reinforcement around openings.</li> <li>■ Drawings and bending schedules should be prepared in accordance with BS 8666.</li> <li>■ Movement joints.</li> </ul>
<b>Formwork</b>	<ul style="list-style-type: none"> <li>■ Formwork materials and features.</li> <li>■ Joints.</li> </ul>	<ul style="list-style-type: none"> <li>■ Mould release agents.</li> <li>■ Holes for services.</li> </ul>
<b>Finishing treatments</b>	<ul style="list-style-type: none"> <li>■ Concrete to be left untouched or with minimum finishing may require detailed formwork drawings indicating the position and detail of joints between shutters, corners and other critical junctions.</li> </ul>	
<b>Testing</b>	<ul style="list-style-type: none"> <li>■ Number and frequency of samples to be taken.</li> <li>■ Test laboratory details.</li> </ul>	<ul style="list-style-type: none"> <li>■ Recording of results.</li> </ul>
<b>Curing and protection</b>	<ul style="list-style-type: none"> <li>■ Requirements for curing and striking formwork.</li> </ul>	<ul style="list-style-type: none"> <li>■ Minimum period for striking/removal of formwork, curing and protection.</li> </ul>

#### 3.1.3 Storage of materials

*Also see: Chapter 3.2*

**Materials shall be properly stored to avoid impairing the performance of the finished concrete.**

Where materials need to be stored, the following precautions should be taken:

- Follow manufacturer's recommendations on maximum storage time.
- Store cement in a dry place and keep each type separate.
- Store different sizes of aggregate in separate bays.
- Keep sand and aggregate clean and dry (allowance should be made in the concrete batching for moisture in the sand and aggregate).

#### 3.1.4 Site-mixed concrete

**Site-mixed concrete shall be designed and mixed to ensure sufficient strength and durability.**

Concrete should be mixed using an appropriate method to achieve the required strength and durability. Except for very small quantities, a mechanical mixer should be used. Where hand mixing, add an extra 10% of cement to the quantities shown in Tables 2 and 3.

**Table 1:** Guidance for site-mixed concrete

Material	Guidance
Cement or cementitious material	<ul style="list-style-type: none"> <li>BS 8500-2 including Annex A.</li> </ul>
Air-entraining admixtures	<ul style="list-style-type: none"> <li>Should not be used in standardised prescribed concrete mixes.</li> </ul>
Admixtures, other than air-entraining admixtures	<ul style="list-style-type: none"> <li>BS EN 934-2.</li> </ul>
Water	<ul style="list-style-type: none"> <li>Mains supply water, or in accordance with BS EN 1008.</li> </ul>
Aggregates	<ul style="list-style-type: none"> <li>Compliant with BS EN 12620 'Aggregates for concrete'.</li> <li>Mixed, and precautions taken, as described in BRE Digest 357.</li> <li>Fine and/or of coarse proportions mixed as specified.</li> <li>Proportioned to ensure a reasonable consistency, when supplied as a mixture.</li> <li>Checked and precautions taken when shrinkable aggregates, aggregates susceptible to alkali attack or excessive moisture movement, or unfamiliar materials are used.</li> <li>Within the limits of the aggregate carbon range (ACR), when subject to aggressive sulfate ground conditions.</li> <li>Assessed in accordance with Technical Requirement R3 where materials are recovered or proprietary.</li> </ul>

The information below applies to cement strength class 32.5 and 20mm maximum aggregate size. Where cement strength class 42.5 or higher is used, the cement weight should be decreased by 10%.

**Table 2:** Mix proportions by weight

Standardised prescribed mix	Consistence class (slump in mm)	Cement (kg)	Fine aggregate (kg)	Coarse aggregate (kg)
ST1	S1 (10-40)	230	770	1155
ST2	S2 (50-90)	265	760	1135
ST2	S3 (100-150)	285	735	1105
ST2	S4 (160-210)	300	815	990
ST3	S2 (50-90)	295	745	1120
ST4	S2 (50-90)	330	735*	1100
ST5	S2 (50-90)	375	720*	1080

\* Fine aggregate grading to be grades CP or MP only of BS EN 12620.

**Table 3:** Mix proportions by volume using a maximum 20mm aggregate size

Cement strength class	Standardised prescribed mix	Consistence class (slump in mm)	Number of (25 kg) bags of cement	Fine aggregate (litres)	Coarse aggregate (litres)
32.5	ST1	S1 (10-40)	1	60	85
	ST2	S2 (50-90)	1	50	75
	ST2	S3 (100-150)	1	45	70
	ST2	S4 (160-210)	1	50	60
	ST3	S2 (50-90)	1	45	65
42.5 or higher	ST1	S1 (10-40)	1	65	95
	ST2	S2 (50-90)	1	55	80
	ST2	S3 (100-150)	1	50	75
	ST2	S4 (160-210)	1	55	65
	ST3	S2 (50-90)	1	50	75

### 3.1.5 Ready-mixed concrete

**Ready-mixed concrete shall be from a supplier operating under a quality control system acceptable to NHBC and be of sufficient strength and durability.**

Ready-mixed concrete is acceptable from suppliers who operate under a full quality control scheme such as:

- the Quality Scheme for Ready-Mixed Concrete (QSRMC),
  - the BSI Kitemark scheme.
- or

Other suppliers may be suitable if they operate to an equivalent quality standard acceptable to NHBC.

Ready-mixed concrete should be ordered to a detailed specification conforming to BS 8500 and BS EN 206-1.

When designated mixes are used, the ready-mix supplier will only require the mix designation, and consistence class.

Ready-mixed concrete should be:

- GEN mix
- FND mix, or
- RC mix.

Delivery information should be checked to ensure that the concrete meets the requirements given in the design.

### 3.1.6 Concrete specification

*Also see: BRE Digest 357, BRE Special Digest 1, BS 8500, BS 8500-1 and BS EN 206-1*

**Concrete shall be specified correctly to ensure adequate strength and durability. Issues to be taken into account include:**

- a) concrete in non-hazardous conditions
- b) exposure to climatic and atmospheric conditions
- c) exposure to aggressive ground conditions
- d) exposure to sulfates and acids in groundwater
- e) effects of chlorides
- f) effects of alkali-silica reaction
- g) aggregates.

Concrete mixes should be suitable for particular end uses and specified in accordance with BS 8500-1 as either:

- designated mix, which is supplied ready mixed, or
- standardised prescribed mix for site mixing.

Designated mixes should conform to Table 5 of BS 8500-2:2012. Standardised prescribed mixes should conform to Tables 2 and 3 in this chapter.

Mixes should also be designed for the expected conditions of the geographical location of the site and the location of the concrete element in the structure. Higher grade concrete has greater resistance to chemical and mechanical damage and should be specified accordingly.

In addition to the issues in this section, durability is reliant on:

- correct control of the water:cement ratio
- full compaction of the placed concrete
- good curing.

#### Concrete in non-hazardous conditions

**Table 4:** Minimum specifications for general purpose concrete mixes

Location and use	BS 8500 and BS EN 206-1		
	Ready-mixed concrete (designated mix)	Site-mixed concrete (standardised prescribed mix)	Consistence class
<b>Substructure and ground floors</b> <ul style="list-style-type: none"> <li>■ Rough blinding (non-structural).</li> <li>■ Infill.</li> <li>■ Unreinforced oversite concrete below timber floors.</li> </ul>	GEN1	ST2	S3
<ul style="list-style-type: none"> <li>■ Structural blinding and over break.</li> <li>■ Strip foundations.</li> <li>■ Trench fill.</li> <li>■ Other mass concrete foundations.</li> <li>■ Fill to wall cavity.</li> <li>■ Solid filling under steps.</li> </ul>	GEN1	ST2	S3/S4 <sup>(1)</sup>
<ul style="list-style-type: none"> <li>■ House floors not designed as suspended and not reinforced: <ul style="list-style-type: none"> <li>– Permanent finish to be added, e.g. screed or floating floor.</li> <li>– No permanent finish to be added, e.g. carpet.</li> </ul> </li> </ul>	GEN1 GEN2	ST2 ST3	S2 S2

**Table 4 (continued):** Minimum specifications for general purpose concrete mixes

Location and use	BS 8500 and BS EN 206-1		
	Ready-mixed concrete (designated mix)	Site-mixed concrete (standardised prescribed mix)	Consistence class
■ Garage floors not designed as suspended and not reinforced.	GEN3	ST4	S2
■ House and garage ground floor slabs: – Fully or nominally reinforced, either ground bearing, suspended or over sub-floor voids.	RC35	ST5 <sup>(2)</sup>	S2
<b>Superstructure</b>			
■ General reinforced concrete exposure class <sup>(3)</sup> to BS8500-1: – Nominal cover to reinforcement of 35mm (which is the minimum cover of 25mm plus an allowance in design for deviation of 10mm). – XC1 (dry) and XC2 (wet, rarely dry). – XC3 (moderate humidity), XC4 (cyclic wet and dry) and XF1 (freeze/thaw attack and no de-icing agent). – Nominal cover to reinforcement of 40mm (which is the minimum cover of 30mm plus an allowance in design for deviation of 10mm). – Any exposure class (XC1-4 and XF1).	RC30 RC40  RC35	<sup>(4)</sup> –  <sup>(5)</sup>	S2 S2  S2
<b>In-situ external concrete</b>			
■ Drives and paths.	PAV1	ST5 <sup>(6)</sup>	S2
■ Foundations for precast concrete paving slabs.	GEN1	ST1	S1

**Notes**

- Consistence class S3 should be used for strip foundation concrete and consistence class S4 should be used for trench fill foundation concrete.
- ST4 mix for house and garage floors may only be used in conjunction with Chapter 5.2 'Suspended ground floors'. In all other cases, the designated mix should be used.
- Exposure classes (XC1-4 and XF1) are defined in BS 8500-1 Table A.1.
- In this situation, ST4 mix may be used only for small quantities of concrete. In all other cases, the appropriate designated mix should be used.
- In this situation, an ST5 mix may be used only for small quantities of concrete. In all other cases, the appropriate designated mix should be used.
- Not suitable in areas of severe exposure to frost attack. This is equivalent to exposure class XC4 above.

**Exposure to climatic and atmospheric conditions**

Any concrete mix should be designed for the conditions expected at the geographical location of the site and at the location of the element in the structure.

**Table 5:** Exposure classes and examples of where they may occur, based on Table 1 of BS EN 206-1

Exposure class	Environment	Exposure conditions
XC1	Dry or permanently wet	Concrete inside buildings with low air humidity. Concrete permanently submerged in water.
XC2	Wet, rarely dry	Concrete surfaces subject to long-term water contact. Many foundations.
XC3	Moderate humidity	Concrete inside buildings with moderate or high air humidity. External concrete sheltered from rain.
XC4	Cyclic wet and dry	Concrete surfaces subject to water contact, not within exposure class XC2.
XF1	Moderate water saturation, without de-icing agent	Vertical concrete surfaces exposed to rain and freezing.

### Concrete in aggressive ground

Mixes should conform to BS 8500. The information in this section describes minimum specifications for lower range 'chemical aggressiveness'. Specialist advice should be sought for more aggressive conditions.

**Table 6:** Aggressive chemical environment for concrete (ACEC) site classification<sup>(1)</sup> and applies to concrete exposed to ground with a pH value greater than 2.5

Sulfate and magnesium				Natural soil		Brownfield <sup>(3)</sup>				ACEC class for site
Design sulfate class for site	2:1 water/soil extract	Ground water	Total potential sulfate <sup>(2)</sup>	Static water	Mobile water	Static water		Mobile water		
1	2	3	4	5	6	7	8	9	10	11
	SO <sub>4</sub>	Mg	SO <sub>4</sub>	Mg	SO <sub>4</sub>	pH	pH	pH <sup>(5)</sup>	pH <sup>(5)</sup>	
	mg/l	mg/l	mg/l	mg/l	%					
DS-1	<500	All Mg values	<400	All Mg values	<0.24	>2.5		>2.5		AC-1s
							>5.5 <sup>(6)</sup>		>6.5	AC-1
							2.5 -5.5		5.5-6.5	AC-2z
									4.5-5.5	AC-3z
									2.5-4.5	AC-4z
DS-2	500-1500	All Mg values	400-1400	All Mg values	0.24-0.6	>3.5		>5.5		AC-1s
							>5.5		>6.5	AC-2
						2.5-3.5		2.5-5.5		AC-2s
							2.5-5.5		5.5-6.5	AC-3z
									4.5-5.5	AC-4z
									<4.5	AC-5z

#### Notes

- For concrete quality and APM for ACEC classes above AC-2z, follow specialist advice. For the full list of ACEC classes, refer to Table A.2 of BS 8500-1 or BRE Special Digest Part C Table C1 for natural ground locations, and Table C2 for brownfield locations.
- Applies only to sites where concrete will be exposed to sulfate ions (SO<sub>4</sub>), which may result from the oxidation of sulfides such as pyrite, following ground disturbance.
- Applies to locations on sites that comprise either undisturbed ground that is in its natural state or clean fill derived from such ground.
- 'Brownfield' is defined as sites which may contain chemical residues remaining from previous industrial use or from imported wastes.
- An additional account is taken of hydrochloric and nitric acids by adjustment to sulfate content.
- For flowing water that is potentially aggressive to concrete owing to high purity or an aggressive carbon dioxide level greater than 15mg/l, increase the ACEC class to AC-2z.

Explanation of suffix symbols to ACEC class number:

- Suffix 's' indicates that, as the water has been classified as static, no additional protective measures are generally necessary.
- Concrete placed in ACEC classes which include the suffix 'z' have primarily to resist acid conditions and may be made with any of the cements or combinations listed in Table D2 of BRE Special Digest 1.

This table is based on Tables C1 and C2 of BRE Special Digest 1.

The information in Table 7 provides guidance on selecting mixes for concrete elements in aggressive ground.

**Table 7:** Design guide for concrete elements in the ground

Concrete element	ACEC class <sup>(1)</sup>	Designated mix
Strip or trench fill foundation, raft foundation, pile <sup>(3)</sup> and ground beams.	AC-1, C1s	As Table 4
	AC-2, C2s	FND2 <sup>(2)</sup>
	AC-2z	FND2z <sup>(2)</sup>

#### Notes

- For all other ACEC classes, follow specialist advice.
- Portland limestone cement may only be used where the design sulfate class (see Table 5) of the site does not exceed DS-1.
- Applies to cast-in-situ piles only – for other types of pile refer to BRE Special Digest 1 or follow specialist advice.

### Exposure to sulfates and acids in groundwater

Sulfates, chemicals and high acidity can cause expansion, cracking and damage to concrete. Where ground water is highly mobile, or where concrete is at risk from chemical attack, the level of sulfate and other chemicals should be determined according to the ACEC class (aggressive chemical environment for concrete class) and BRE Special Digest 1.

For higher ACEC classes, specialist advice should determine the design chemical class (DC class) and appropriate additional protective measures (APM) where required. Table A.7 of BS 8500-1 should be used to select the mix specification.

For lower ACEC classes (AC-1, AC-1s, AC-2, AC-2s and AC-2z), information in Tables 6 and 7 should be used to select the mix specification.

### Effects of chlorides

Chlorides, which are contained in all concrete materials, increase the risk of corrosion in metal and can reduce the chemical resistance of concrete, therefore chloride content of fresh concrete should be limited in accordance with BS EN 206-1 Table 10.

Cured concrete can be damaged by chlorides in the ground, sea spray, or products used for de-icing highways, and specialist guidance should be followed.

### Effects of alkali-silica reaction

Alkalis can cause expansion, cracking and damage to concrete. Damage can occur when all the following conditions are present:

- a source of alkali
- a high moisture content
- where the aggregate is alkali reactive.

Alkali content calculated in accordance with BRE Digest 330 or Concrete Society Technical Report 30 should not exceed 3kg/m<sup>3</sup>. Where unfamiliar aggregate materials are used, special precautions may be required.

Standardised prescribed mixes should conform to BS 8500.

### Aggregates

Aggregates should be of a grade which ensures adequate durability of the concrete. Certain types of aggregate are shrinkable and require special precautions in mixing. Certain types of aggregate may be susceptible to alkali attack or excessive moisture movement.

Proprietary and recovered aggregates should only be specified where they have been assessed in accordance with Technical Requirement R3.

## 3.1.7 Admixtures

**Admixtures shall only be used to enhance the performance and durability of concrete.**

Issues that should be taken into account include:

- improved workability
- waterproofing
- foaming agents
- accelerated strength
- retardation
- chlorides.

Admixtures should comply with BS EN 934-2 Admixtures for concrete mortar and grout - Concrete admixtures - Definitions, requirements, conformity, marking and labelling, should be used in accordance with BS EN 206-1 should be:

- specified only with full knowledge of their limitations and effects
- used only where permitted in the specification
- tested in trial mixes, where necessary
- added to the mix water to ensure complete dispersal
- dosed correctly
- used strictly in accordance with the manufacturer's instructions.

Accelerators produce early setting of the concrete, and plasticisers can improve concrete cohesion and the bond with reinforcement.

Air-entraining agents should not be used as an anti-freeze for fresh concrete. Though they can increase the frost resistance of cured concrete and are recommended for paths, drives and pavements which are likely to be exposed to freezing conditions.

Retarding agents can increase the risk of frost damage.

Admixtures containing chlorides can cause metal corrosion and should not be used in reinforced concrete.

### 3.1.8 Special types of concrete

**Special types of concrete shall be appropriate for their use.**

Proprietary concrete, no-fines or lightweight concrete should be of a quality and density appropriate for the conditions and use. Where no-fines concrete is used, a render, cover coat or cladding should be applied to the finished structure.

Proprietary methods of reinforcement, e.g. glass fibre, should be assessed in accordance with Technical Requirement R3.

Structural design should be in accordance with Technical Requirement R5 and the mix properly detailed.

### 3.1.9 Design of reinforced concrete

*Also see: BS EN 1992-1-2*

**Reinforced concrete shall be suitable for its intended use. Issues to take into account include:**

- |  |                    |
|--|--------------------|
| a) compliance with appropriate standards | d) fire resistance |
| b) end restraint                         | e) carbonation.    |
| c) concrete cover                        |                    |

Reinforced concrete should be designed by an engineer in accordance with Technical Requirement R5. BS 8103-4 can be used for the design of suspended ground floors in homes and garages.

#### Compliance with appropriate standards

The steel specification should indicate the steel type, grade and size. Drawings and bending schedules should be prepared in accordance with BS 8666 and include all necessary dimensions for completion of the sitework. Reinforcement should comply with the standards listed below.

<b>BS EN 1992-1</b>	'Design of concrete structures'.
<b>BS 4449</b>	'Steel for the reinforcement of concrete'. Specification
<b>BS 4482</b>	'Steel wire for the reinforcement of concrete products'. Specification
<b>BS 4483</b>	'Steel fabric for the reinforcement of concrete'. Specification
<b>BS 6744</b>	'Stainless steel bars for the reinforcement of and use in concrete'. Requirements and test methods
<b>BS 8103-1</b>	'Structural design of low-rise buildings'. Code of practice

#### End restraint

Where the ends of slabs are cast monolithically with concrete members, surface cracking may develop over the supports. Reinforcement should therefore be provided in accordance with BS EN 1992-1-1.

#### Concrete cover

There should be adequate cover to the reinforcement, especially where it is exposed or in contact with the ground. Cover should be adequate for all reinforcement, including main bars and stirrups. No ties or clips should protrude into the concrete cover.

For concrete not designed by an engineer, the minimum cover for reinforcement should be in accordance with Table 8.

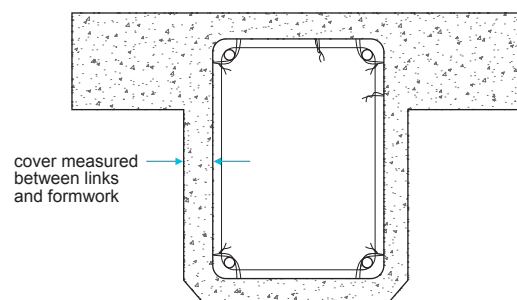

**Table 8:** Minimum cover for reinforcement for concrete not designed by an engineer

Position of the concrete	Minimum cover (mm)
In contact with the ground.	75
External conditions.	50
Cast against a DPM on sand blinding.	40
Against adequate blinding concrete.	40
Protected or internal conditions.	25



## Fire resistance

Concrete cover to reinforcement should be adequate to resist fire. Requirements for fire resistance are given in BS EN 1992-1-2. Cover required by BS EN 1992-1-1 will normally provide up to one hour of fire resistance for columns, simply supported beams and floors.

## Carbonation

Carbonation reduces the corrosion protection of the reinforcement by increasing porosity and decreasing alkalinity. Such corrosion can be reduced by providing as much concrete cover as possible, and by ensuring that the wet concrete is of good quality and properly compacted to reduce the rate of carbonation.

### 3.1.10 Installation of reinforcement

Also see: Chapter 5.2

**Reinforcement shall be installed in accordance with the design. Issues to take into account include:**

- a) shape, placing and condition of reinforcement bars
- b) lapping bars and mesh
- c) support for reinforcement.

#### Shape, placing and condition of reinforcement bars

<b>Main reinforcing bars</b>	Should be parallel to the span, or as detailed in the design.
<b>Slab reinforcement</b>	Should be located near the bottom of the slab, with the main reinforcing bars placed first and the secondary bars on top.
<b>Beams</b>	Should have the main reinforcing bars placed inside the links.

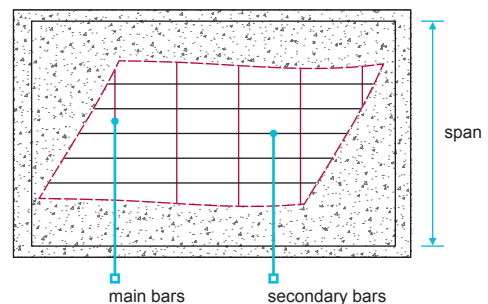

Reinforcement should be:

- bent using appropriate equipment and placed in accordance with the design
- clean and free from loose rust and contaminants, especially shutter-releasing agents and oil.

#### Lapping bars and mesh

Reinforcing bars or mesh should be lapped according to type and size as indicated by the designer to ensure that loads are fully transferred across the lap. Any additional laps require the designer's approval.

#### Support for reinforcement

Spacers should be either concrete blocks (no more than 50 x 50mm) or ready-made of steel or plastic. Supports should be placed no more than one metre apart, or closer where necessary.

Spacers for parallel bars should be staggered to avoid creating a plane of weakness in the concrete. Supports for top steel should be chairs, or other proprietary products.

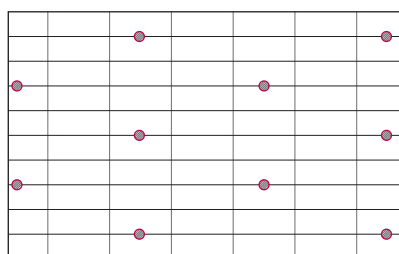

spacers staggered to avoid planes of weakness

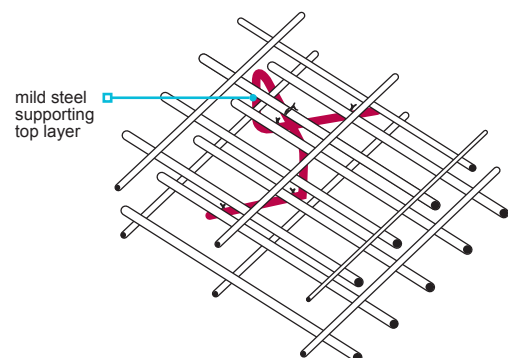

### 3.1.11 Blinding concrete

**Blinding concrete shall be used where required to aid construction.**

Blinding concrete should only be used:

- to protect the bottom of the trench/excavation where there is a delay in pouring structural concrete
- where the foundation has been slightly overdug
- to provide sufficient support to ensure cover to reinforcement is maintained, or
- where localised soft spots have been removed.

### 3.1.12 Formwork

**Formwork shall be structurally adequate and constructed in a workmanlike manner.**

Formwork should be accurately set out in relation to relevant reference lines and benchmarks. Accuracy is essential to ensure that the correct cover to the reinforcement is maintained.

Formwork and its supports should be rigid enough to maintain the correct position and to withstand extra loads and accidental knocks likely to occur during placement and compacting. Wedges, inserts and boxes should be firmly secured to avoid displacement during vibration.

For concrete which is to be left untreated, or with minimum finishing, formwork joints should be tight to avoid grout loss and ragged edges. Joints between shutters should be constructed for easy stripping. Any holes for bolts or spacers should be drilled with care to avoid disfiguring or splintering the formwork surface and giving a poor finish.

Formwork should be capable of being struck without damage to the concrete. Formwork should be dismantled without shock, disturbance or damage to the concrete. Support for load-bearing elements should not be removed until the concrete has achieved sufficient strength, as detailed by the designer. Props under suspended floors or beams should be released from the centre, outwards, to avoid overloading.

### 3.1.13 Before concreting

**Installations and final preparations shall be completed before concreting starts.**

Before concreting starts:

- all services, ducts, inserts, etc. to be embedded in the concrete should be securely installed in the correct position and, where appropriate, tested
- completed reinforcement should be checked and, where necessary, approved by the designer or their representative
- formwork should be cleaned out and checked for fallen debris, especially nails and wire clippings.

### 3.1.14 Casting

*Also see: Chapter 3.2*

**Concrete shall be cast so as to achieve the required design strength and durability.**

The temperature of the concrete at the point of use should not be less than 5°C (41°F). Fresh concrete is susceptible to frost damage, and freezing can cause internal damage that is not immediately obvious.

Concrete should not be placed in or under water, unless it has been specially designed for that use.

Sufficient concrete should be mixed or ordered, so that it can be placed in a continuous process.

Concrete should be deposited as close as possible to its final location. Transportation on site should be as fast and efficient as possible in order to avoid segregation and to ensure full compaction of the placed concrete.

Site-mixed concrete should be placed within 30 minutes, and ready-mixed concrete within two hours, of water being added to the cement. Additional water should not be added to ready-mixed concrete unless under the supervision and approval of the supplier.

Concreting should, wherever possible, be carried out in one operation, taking account of:

- weather conditions
- available daylight
- time to allow for surface finishing.

Concrete cast in one operation (i.e. without construction joints) should always be as square in shape as possible and not greater than:

- reinforced concrete 60m<sup>2</sup>
- unreinforced concrete 16m<sup>2</sup>

Construction joints should be formed only where unavoidable and in consultation with the engineer. These should not be positioned next to a return in the foundation. Before work continues beyond the joint, shuttering used to form the joint should be removed.

Reinforced concrete should be fully compacted using poker vibration unless the design states otherwise. Poker vibration should be carried out by experienced operators to ensure complete coverage and to avoid honeycombing. Vibrating beams or hand tamping may be used to consolidate slabs up to 150mm thick, unless the design details otherwise. Excessive use of vibration can cause segregation and prevent concrete reaching an adequate strength.

### 3.1.15 Curing

*Also see: Chapter 3.2*

**Concrete shall be adequately cured to achieve full design strength.**

Concrete performance relies on the curing process. The design should clearly indicate where there are any special requirements for curing concrete.

Freshly poured concrete should be kept moist by covering as soon as the surface is hard enough to resist damage. This is particularly important in hot, windy or cold weather to prevent the surface drying out too rapidly, or freezing. Damp hessian, damp sharp sand or an impervious sheet (such as polyethylene) are acceptable as surface coverings. Alternatively, a curing agent can be applied to the surface.

No load should be applied to the work until the concrete has cured sufficiently. It is recommended that plain unreinforced concrete made with ordinary Portland cement is left for at least four days to cure.

It is possible to proceed with substructure masonry above strip or trench fill foundations on unreinforced ordinary Portland cement concrete at an early stage, provided that care is taken to protect the surface from damage.

Reinforced concrete or concrete containing cement replacements, such as PFA, will require a longer curing period. This will normally take seven days, during which the concrete structure should not be loaded.

Any curing agents should comply with Technical Requirement R3 and should be applied strictly in accordance with the manufacturer's instructions. Curing agents should never be used on floors which are to receive either a topping or a screed, as it could affect the future bond. Curing periods may be extended at low temperatures.

### 3.1.16 Testing

**Testing shall be carried out to the full satisfaction of NHBC.**

Testing, where required, shall be conducted to BS EN 12390 by UKAS approved laboratories. Test cubes should be prepared as requested by the engineer. These should be marked, cured and stored safely until testing.

Proof of testing, with reports, certificates and allied documentation, should be kept for reference and made available to NHBC upon request.

Ready-mixed concrete supplier should prepare test cubes in accordance with quality assurance procedures.

## 3.1.17 Glossary

<b>Aggressive chemical environment for concrete classification (ACEC class)</b>	A system for the classification of aggressive ground conditions that are derived from design sulfate class. It takes into account the site (natural or brownfield) and the mobility and pH of ground water. Brownfield, 'mobile' water and low pH (acidic) conditions may have adverse effects on buried concrete and hence result in a more severe ACEC class.
<b>Additional protective measures (APM)</b>	These are defined as the extra measures that could be taken to protect concrete where the basic concrete specification might not give adequate resistance to chemical attack.
<b>Design chemical class (DC class)</b>	This defines the qualities of concrete that are required to resist chemical attack. The DC class is derived from the ACEC class of the ground and other factors, including the type of concrete element and its required structural performance.
<b>Design sulfate class (DS class)</b>	A site classification based on the determined sulfate (including potential sulfate) contents of the ground and/or ground water. It is also dependent on the type of site, presence or absence of magnesium ions, pyrite, and for pH less than 5.5, chloride and nitrate ions. Five levels of classification are given that are equivalent to those given in BRE Digest 363 (now superseded).
<b>Enhanced concrete quality</b>	An incremental step in concrete quality that could be used as an Additional Protective Measure (APM). Each increment in concrete quality is counted as an extra APM.
<b>Mobile ground water</b>	Sites where water is free to flow into an excavation to give a standing water level are affected by mobile ground water. The threshold ground permeability is greater than $10^{-6}$ m/s (i.e. 86 mm/day).
<b>Static ground water</b>	The sites where the free flow of water is confined due to either permanently dry conditions or the soil is relatively impermeable (of permeability less than $10^{-6}$ m/s).
<b>Total potential sulfate (TPS)</b>	The total potential sulfate content is the result of the combination of sulfates already present in the ground and that which may be added due to the oxidation of pyrite in the ground.

# Cold weather working

## CHAPTER 3.2

This chapter gives guidance on meeting the Technical Requirements for cold weather working.

3.2.1	Compliance	01
3.2.2	External conditions	01
3.2.3	Materials	01
3.2.4	Concreting	01
3.2.5	Masonry	02
3.2.6	Rendering, plastering and screeding	02
3.2.7	Admixtures	03
3.2.8	Painting	03



### 3.2.1 Compliance

Also see: Chapter 2.1

**Cold weather working shall comply with the Technical Requirements.**

Sitework which complies with the guidance in this chapter will generally be acceptable.

### 3.2.2 External conditions

Also see: Meteorological Office

**Allowance shall be made for cold weather conditions during construction.**

Work should be planned in advance, and account taken of site and climatic conditions either by:

- stopping work, or
- taking adequate precautions.

The following conditions should be considered when scheduling work:

- Wind (this can create a cooling effect which can reduce temperatures further, i.e. affecting the curing of concrete and mortar).
- Shade (in particular high trees or adjacent buildings can block low winter sun and reduce temperatures further).
- Valleys (sites in valleys are susceptible to increased risk of frost).

Where air temperature is below, or likely to fall below, 2°C, work should not proceed unless the precautions detailed in this chapter are adopted.

A thermometer should be sited in the shade and used to indicate if temperatures are rising or falling.

### 3.2.3 Materials

**Materials shall be adequately protected against cold weather.**

Materials should:

- not be used if frozen
- be protected using appropriate covers to prevent damage by snow, ice, frost or damp.

Appropriate covers should be provided for bricks and blocks, sand, aggregates and cement, to prevent them from becoming saturated and damaged by frost.

Where it is necessary to continue building during longer periods of colder weather, heaters should be used to protect materials.

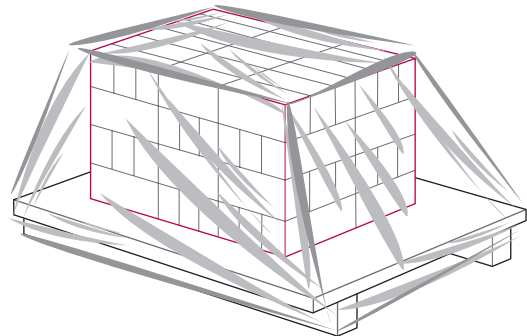

### 3.2.4 Concreting

Also see: BS EN 13670 Table 4 Curing class 2 and Table F1 Curing class 2

**Concrete shall not be placed in cold weather unless suitable precautions are taken.**

The minimum temperature of ready-mixed concrete when delivered should be 5°C, in accordance with BS EN 206-1.

When concreting is undertaken during colder weather, curing periods should be adjusted according to environmental conditions. Concrete should:

- be covered to maintain the temperature above freezing, and heated if necessary
- not be placed where the ground, oversite or the surfaces that will be in contact with the concrete are frozen
- be placed with caution where small quantities of fresh concrete are against a large volume of hardened concrete which is at a lower temperature.

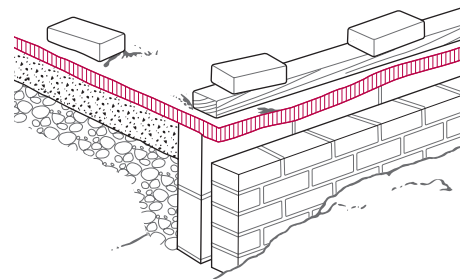

Where slight overnight frosts are expected, 50mm of insulation held down firmly at the edges should be used to help protect oversite concrete. Where very severe frosts are expected, insulation alone is inadequate and heating should be provided.

### Site-mixed concrete

If the air temperature drops to 2°C, concrete work should not proceed unless:

- the ground into which the concrete is to be placed is not frozen
  - the aggregate temperature is above 2°C
  - the aggregate is free of frost and snow
  - the water for mixing is heated, but not above 60°C (cement should not be heated)
  - the cast concrete can be properly protected, taking account of the cross-sectional area and location.
- In prolonged or very severe cold weather:
- covers will not stop severe frost penetrating the aggregate
  - where work is to continue, it may be necessary to steam heat aggregates or to use hot air blowers below covers
  - heating the mixing water cannot be relied upon to thaw frozen aggregates, and very cold aggregate can still remain frozen.

### 3.2.5 Masonry

**Masonry shall not be laid in cold weather unless suitable precautions are taken.**

When laying masonry in cold weather:

- and temperatures are below, or are likely to fall below, 2°C (temperatures should be checked throughout the day on a thermometer), masonry should not be laid unless heating is provided and newly laid masonry protected
- materials which have been damaged by frost or are frozen should not be used
- additional covers and insulation will be necessary at very low temperatures
- polyethylene covers should be used to provide protection and prevent work from becoming saturated (an air gap between the masonry and the covers will enable new masonry to cure)
- where very severe frosts are expected, heaters may be required
- protection against frost may be required for up to six days, depending on the severity of the conditions.

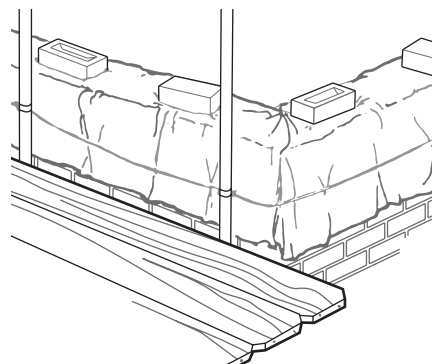

### 3.2.6 Rendering, plastering and screeding

*Also see: Chapter 6.11*

**Rendering, plastering and screeding shall not be carried out in cold weather unless suitable precautions are taken.**

Rendering, plastering and screeding should not be carried out if there is frost on the structure.

Where warm air heaters are used to warm the structure before screeding and plastering takes place, they should:

- keep the temperature of the structure above freezing during the curing period
- not produce water vapour (the building should be ventilated to disperse moisture)
- be placed in the room a day before plastering is to start
- be used for longer following a prolonged cold period (as ground floors and walls near to floor level may be slow to respond)
- continue heating for at least 48 hours after completion of the work but not be excessive (to avoid damage to screeds, plaster finishes and woodwork).

Render should not be applied if:

- the temperature is below, or likely to fall below, 2°C (temperatures should be checked throughout the day on a thermometer)
- backgrounds are saturated or frozen, or
- there is a possibility that new work will be subjected to frost before it has set.

### 3.2.7 Admixtures

**Admixtures shall be used correctly and in accordance with the manufacturer's recommendations.**

When using admixtures:

- accelerators may assist the mortar or concrete to set before temperatures fall (admixtures do not prevent frost damage to uncured concrete or mortar)
- plasticisers can entrain air during mixing to provide frost resistance to mature mortar and concrete
- in cold weather, retarding agents should not be used as they can increase the setting times of cement
- in cold weather, bonding agents may be ineffective
- those containing calcium chloride should be avoided.

### 3.2.8 Painting

**Painting shall not be carried out when there is a risk of damage due to cold weather.**

Paint should not be applied:

- on surfaces affected by damp, frost or condensation
- where the air temperature is below, or likely to fall below 2°C
- when condensation, snow or rain is likely to affect paintwork before it is dry.



# Timber preservation (natural solid timber)

## CHAPTER 3.3

This chapter gives guidance on meeting the Technical Requirements for the protection of natural solid timber against fungal decay when exposed to damp conditions and against insect attack.

3.3.1	Compliance	01
3.3.2	Durability	01
3.3.3	Sitework	03
3.3.4	Protection and storage	03
3.3.5	Treatment of cut surfaces	03
3.3.6	Compatibility with metal	03
3.3.7	Further information	03



### Introduction

This chapter gives acceptable treatment schedules for the treatment of natural solid timber but does not cover:

- products such as plywood and wood particle boards
- the condition before the treatment
- treatment process techniques, which is the responsibility of the organisation carrying out the operation.

### 3.3.1 Compliance

Also see: Chapter 2.1

**Timber preservative treatments and processes shall comply with the Technical Requirements and reasonably ensure that the timber is safely and satisfactorily protected against fungal decay and insect attack.**

Timber preservative treatments that comply with the guidance in this chapter will generally be acceptable. Timber and external joinery should either be:

- naturally durable and resistant to insect attack, or
- treated with preservative in accordance with this chapter.

It is important that treatment of timber and joinery is carried out to appropriate standards which are both suitable and safe. Treatments in accordance with procedures set out in British Standards, Codes of Practice, or which have been satisfactorily assessed by an independent authority in accordance with Technical Requirement R3, will generally be acceptable. The specification should state the specific treatment and standard required.

All preservatives should meet the requirements of the Control of Pesticides Regulations (1986) administered by the Health and Safety Executive. The safety instructions published by the manufacturers should be followed.

### 3.3.2 Durability

**Timber and joinery used in the construction of homes shall either have adequate natural durability or, where treatment is undertaken, receive a satisfactory preservative treatment against fungal decay and insect attack.**

Timber component groups and preservative treatment required are shown in Table 1 below (based on BS 8417), which provides information to establish the appropriate type of treatment according to the particular element and conditions of use. Table 2 provides information on the timber species and durability.

**Table 1:** Timber component groups and preservative treatment

Component group	Examples	Use class	Desired service life	Preservative type required				Preservative treatment not required
				Copper organic <sup>(1)</sup>	Water-based organic <sup>(1)</sup>	Organic solvent or microemulsion <sup>(1)</sup>	Boron <sup>(2)</sup>	
Internal joinery, intermediate floor joists	Architraves, internal doors, intermediate floor joists	1	60	✓	✓	✓	✓	Unless a specific request for treatment against insect attack has been made.
Roof timbers (dry)	Pitched roofs: rafters, purlins, joists, wall plates	1	60	✓	✓	✓	✓	Unless a specific request for treatment against insect attack has been made.
Roof timbers (dry) in areas with house longhorn beetle	As above	1	60	✓	✓	✓	✓	Where timber used is: <ul style="list-style-type: none"> <li>■ softwood – heartwood only<sup>(3)</sup> and of durability class 1 – 3<sup>(4)</sup> or</li> <li>■ hardwood.</li> </ul>
Roof timbers (risk of wetting)	Flat roofs joists, sarking, tiling battens, valley boards, timbers exposed to risk of condensation, porch posts – coated and held clear of the ground and standing water, in a free draining shoe made from suitably durable material such as galvanized or stainless steel.	2	60	✓	✓	✓	✓	Where timber used is: <ul style="list-style-type: none"> <li>■ heartwood only<sup>(3)</sup> and of durability class 1 – 2<sup>(4)</sup></li> </ul>
Roof timbers (risk of wetting) in areas with house longhorn beetle	As above	2	60	✓	✓	✓	✓	Where timber used is heartwood only <sup>(3)</sup> and of durability class 1 – 2 <sup>(4)</sup> .

**Table 1 (continued):** Timber component groups and preservative treatment

Component group	Examples	Use class	Desired service life	Preservative type required				Preservative treatment not required
				Copper organic <sup>(1)</sup>	Water-based organic <sup>(1)</sup>	Organic solvent or microemulsion <sup>(1)</sup>	Boron <sup>(2)</sup>	
External walls/ ground floors	Timber frames, ground floor joists, I-beam studwork	2	60	✓	✓	✓	✓	Where timber used is heartwood only <sup>(3)</sup> and of durability class 1 – 2 <sup>(4)</sup> .
Sole plates <sup>(5)</sup>		2	60	✓	✓	✓	✓	Where timber used is heartwood only <sup>(3)</sup> and of durability class 1 – 2 <sup>(4)</sup> .
External joinery, coated (not in ground contact) <sup>(6)</sup>	Window frames, door frames, doors, cladding (coated), soffits, fascias, barge boards	3	30	(7)	(7)	✓	✓	Where timber used is heartwood only <sup>(3)</sup> and of durability class 1 – 2 <sup>(4)</sup> .
Uncoated external timbers (not in ground contact)	Decking (where the deck is up to 600mm from ground level) <sup>(8)</sup> , cladding (uncoated)	3	15	✓	✓	x	x	Where timber used is heartwood only <sup>(3)</sup> and of durability class 1 – 2 <sup>(4)</sup> .
Timber in contact with the ground	Decking timber in ground contact (where the deck is up to 600mm from ground level) <sup>(8)</sup>	4	15	✓	x	x	x	Where timber used is heartwood only <sup>(3)</sup> and of durability class 1 – 2 <sup>(4)</sup> .
Timber in contact with the ground	Timber retaining walls up to 1m high and within garden areas <sup>(7)</sup>	4	15	✓	x	x	x	Where timber used is heartwood only <sup>(3)</sup> and of durability class 1 – 2 <sup>(4)</sup> .
Timber in contact with the ground	Timber retaining walls greater than 1m high and within garden areas <sup>(7)</sup>	4	30	✓	x	x	x	Where timber used is heartwood only <sup>(3)</sup> and of durability class 1 <sup>(4)</sup> .
Timber in contact with the ground	Timber retaining walls up to 600mm high and in a boundary situation <sup>(9)</sup>	4	30	✓	x	x	x	Where timber used is heartwood only <sup>(3)</sup> and of durability class 1 <sup>(4)</sup> .

- Notes
- 1.Preservative treatment of timber should be in accordance with the recommendations of BS 8417, Table 4.
  - 2.Preservative treatment of timber should be in accordance with the recommendations of BS 8417, Table 5.
  - 3.Almost always, packs of timber contain sapwood. It should be assumed that timber is sapwood and preservative treated accordingly unless the timber has been specifically selected as heartwood only.
  - 4.Natural durability classes are given in Table 2.
  - 5.Sole plates should be positioned above DPC. Preservatives used should be resistant to leaching or, for boron, treatment should be to full cross-section retention standard. Treatment should be carried out in accordance with BS 8417.
  - 6.The hardwoods known as Meranti, Seraya or Lauan should be treated in the same way as European redwood / Scots Pine when used for joinery.
  - 7.The pressure treatment process used for these types of preservative will cause timber to swell, so these treatments are generally not used for window or door frames and other uses where dimensional precision is required.
  - 8.Decking that is more than 600mm in height should have a desired service life of 60 years. Reference should be made to Chapters 7.1 'Flat roofs and balconies' and 10.2 'Drives, paths and landscaping'.
  - 9.Where timber structures more than 600mm high are used for retaining ground in boundary situations, they should be designed with a desired service life of 60 years. Reference should be made to Chapter 10.2 'Drives, paths and landscaping'.

**Table 2:** Natural durability of building timbers (heartwood only)

Durability class	1. Very durable	2. Durable	3. Moderately durable	4. Slightly durable	5. Not durable
Hardwoods	<ul style="list-style-type: none"> <li>■ Kapur (Sabah, Burma)</li> <li>■ Padauk (white, Andaman)</li> <li>■ Teak (Malaysian)</li> <li>■ Opepe</li> <li>■ Afromosia</li> <li>■ Greenheart</li> <li>■ Guarea</li> <li>■ Iroko</li> <li>■ Jarrah</li> <li>■ Okan</li> <li>■ Pyinkado</li> <li>■ Peroba</li> </ul>	<ul style="list-style-type: none"> <li>■ Oak (American white, European)</li> <li>■ Mahogany (American)</li> <li>■ Chestnut (sweet)</li> <li>■ Louro (red)</li> <li>■ Basralocus</li> <li>■ Ekki</li> <li>■ Karri</li> <li>■ Kempas</li> </ul>	<ul style="list-style-type: none"> <li>■ Keruing (Sabah, Malaysian)</li> <li>■ Oak (Tasmanian, Turkey)</li> <li>■ Mahogany (African)</li> </ul>	<ul style="list-style-type: none"> <li>■ Oak (American red)</li> <li>■ Elm (Dutch, English, white, rock, wych)</li> <li>■ Beech (silver)</li> </ul>	<ul style="list-style-type: none"> <li>■ Birch (silver, European, paper, yellow)</li> <li>■ Chestnut (European horse)</li> <li>■ Beech (European)</li> <li>■ Sycamore</li> <li>■ Alder</li> <li>■ Lime</li> </ul>

**Table 2 (continued):** Natural durability of building timbers (heartwood only)

Durability class	1. Very durable	2. Durable	3. Moderately durable	4. Slightly durable	5. Not durable
Softwoods	None	<ul style="list-style-type: none"> <li>■ Cedar (imported western red)</li> </ul>	<ul style="list-style-type: none"> <li>■ Larch (European, hybrid, Japanese, tamarack, western, maritime)</li> <li>■ Fir (North American Douglas, UK Douglas)</li> <li>■ Pine (Caribbean pitch, American pitch)</li> <li>■ Cedar (UK western red)</li> </ul>	<ul style="list-style-type: none"> <li>■ Pine (Canadian red, Corsican, jack, parana, ponderosa, radiata, Scots, southern, western white, yellow, lodgepole)</li> <li>■ Spruce (Eastern Canadian, Engelmann, European whitewood, Sitka, western white)</li> <li>■ Fir (noble, silver, balsam, grand)</li> <li>■ Hem-fir (USA and Canada)</li> <li>■ Redwood (European)</li> </ul>	None

### 3.3.3 Sitework

**Sitework shall follow established good practice and workmanship.**

Checks should ensure that, when timber is delivered to site, timber and joinery products have received the specified treatment. This should be stated on the delivery note.

### 3.3.4 Protection and storage

**Timber and joinery shall be stored and protected to ensure it is in a suitable condition for use.**

It is important when timber and joinery products are stored that they are:

- protected from damage immediately upon delivery
- protected from the weather
- stored off the ground
- stored to limit the risk of distortion
- stored to allow air to circulate.

### 3.3.5 Treatment of cut surfaces

**Timber which has been preservative treated and cut shall be retreated on the cut surfaces.**

Timber should not be cut after treatment, but where this is unavoidable, all such surfaces should be retreated with a suitable colour tinted preservative, to enable confirmation that re-treatment has occurred. Only in situations where colour tinting will affect the appearance of the timber fixed to the home will clear preservatives be acceptable.

Applied preservatives should be compatible with the original treatment.

### 3.3.6 Compatibility with metal

**Measures shall be taken to prevent adverse effects from incompatibility between metal components and treated timber.**

Copper-containing treatments can cause corrosion between mild steel and aluminium. Where moisture is expected, the following fittings should be used when in contact with timber treated with copper-containing preservatives:

- Occasional dampness – galvanised fittings
- Likely wetting – austenitic stainless steel fittings.

Timber treated with copper containing preservatives should be re-dried to a moisture content of 20% for at least seven days before being in contact with metal fittings.

### 3.3.7 Further information

- *BS 8417 'Preservation of Timber – Recommendations'*
- *BS EN 599 – Part 1 'Durability of wood and wood-based products – Performance of preventive wood preservatives as determined by biological tests'*
- *Part 1: 'Specification according to hazard class. Industrial Wood Preservation – Specification and Practice' ('WPA Manual') (2008)*
- *The Wood Protection Association, 5C Flemming Court, Castleford, West Yorkshire, WF10 5HW, UK, Tel: 01977 558274, Email: [info@wood-protection.org](mailto:info@wood-protection.org)*

# Land quality – managing ground conditions

## CHAPTER 4.1

This chapter gives guidance on meeting the Technical Requirements for assessing and managing land quality.

4.1.1	Compliance	01
4.1.2	Initial Assessment – desk study (all sites)	03
4.1.3	Initial Assessment – walkover survey (all sites)	04
4.1.4	Initial Assessment – results	04
4.1.5	Basic Investigation (sites where hazards are not identified or suspected)	05
4.1.6	Detailed Investigation (sites where hazards are identified or suspected)	05
4.1.7	Managing the risks (sites where hazards are found)	06
4.1.8	Unforeseen hazards	06
4.1.9	Documentation and verification	07
4.1.10	Guidance for investigations	07
4.1.11	Further information	08



### Introduction

This chapter provides a framework for managing geotechnical and contamination risks, with the objective of ensuring that:

- all sites are properly assessed and investigated for potential geotechnical and contamination hazards
- foundations and substructure designs are suitable for the ground conditions
- sites are properly remediated where necessary or appropriate, and design precautions are taken
- appropriate documentation and verification is provided to NHBC.

### 4.1.1 Compliance

*Also see: Chapter 4.2*

**Assessment of the site and the surrounding area shall comply with the Technical Requirements.**

**Items to be taken into account include:**

- a) suitability of persons for the level of investigation
- b) geotechnical and contamination issues
- c) investigation procedures
- d) notification in writing to NHBC of hazardous ground conditions.

Ground investigations and management of risk that complies with the guidance in this chapter will generally be acceptable.

#### Suitable persons for the level of investigation

The following skills and knowledge are required from the person responsible for the Initial Assessment, Basic Investigation and documentation and verification. They should:

- understand the hazards that can affect the development and where they originate
- recognise the signs of potential hazards
- conduct a desk study and walkover survey
- collect information relating to such hazards on and adjacent to the site
- report the findings in a clear and concise manner
- determine when specialist advice and detailed testing is required.

The following criteria should be used as guidance for the appointment of a consultant or specialist responsible for Detailed Investigation, management of hazards, documentation and verification:

<b>Experience</b>	Similar types of site and development.
<b>Appropriate discipline(s)</b>	Understanding of all relevant skills required on the project and access to other disciplines, including geologists, hydrogeologists, toxicologists and environmental chemists.
<b>Legislation</b>	Understanding of legislation and liabilities associated with the site.
<b>Professional indemnity insurance</b>	Appropriate cover for the work being carried out.
<b>Health and safety</b>	Awareness of occupational hygiene issues and Health and Safety legislation.
<b>Quality assurance</b>	Use of a quality management system, including appropriately accredited laboratories.
<b>Project management</b>	Ability to manage a project team consisting of the appropriate disciplines.
<b>Site investigation</b>	Ability to design site investigation programmes, including soil sampling, testing and laboratory analysis.
<b>Risk management</b>	Ability to conduct risk assessments as required by the risk management process.
<b>Reporting and communication</b>	Ability to prepare comprehensive and well presented reports. Effective communication within their organisation and with the client, statutory authorities and the general public.
<b>Engineering design</b>	Understanding of effective risk reduction techniques, e.g. engineered foundations and substructure details of suitable remediation.

#### Geotechnical and contamination issues

Assessment should be carried out by direct investigation and examination of the ground, supplemented by laboratory testing where necessary, in order to determine the geotechnical and contamination characteristics of the site.

Specifically, where contamination is suspected or found, the site should be assessed using the Source-Pathway-Receptor framework (known as the pollutant linkage).

For land contamination to occur, a source, pathway and receptor must all exist. A written or diagrammatic representation of the land contamination (known as a Conceptual Model), should be produced to show the possible relationships between each.

## Procedure

The process to assess and manage the ground conditions is as follows:

### Initial Assessment

NHBC requires all sites to be assessed by a desk study and a walkover survey. The results should be used to determine whether or not hazards are known or suspected.

### Basic Investigation

Required to support the results of the Initial Assessment where hazards are not suspected.

### Detailed Investigation

Required where hazards are known or suspected.

### Further Assessment

Required after the Basic or Detailed Investigation has been conducted, to confirm that all objectives have been met. Where results are inconclusive, further investigation will be required.

### Hazards

Where hazards are identified, design precautions or remediation will be required to minimise their effects.

If any unforeseen hazards are found during the course of construction, further investigation may be required.

### Documentation and verification

NHBC requires documentation and verification to show that:

- the site has been properly assessed and investigated
- where necessary, suitable precautions are incorporated into the design
- all necessary remediation has been carried out.

### Notification of potential hazards and associated risks

If a site (defined in the Rules as an area of land that is covered by a single detailed planning consent or series of consents relating to continuous development) is classed as 'hazardous', NHBC must be notified in writing a minimum of eight weeks before work starts. Failure to provide such information may delay the registration process, the construction work and the issuing of NHBC warranty.

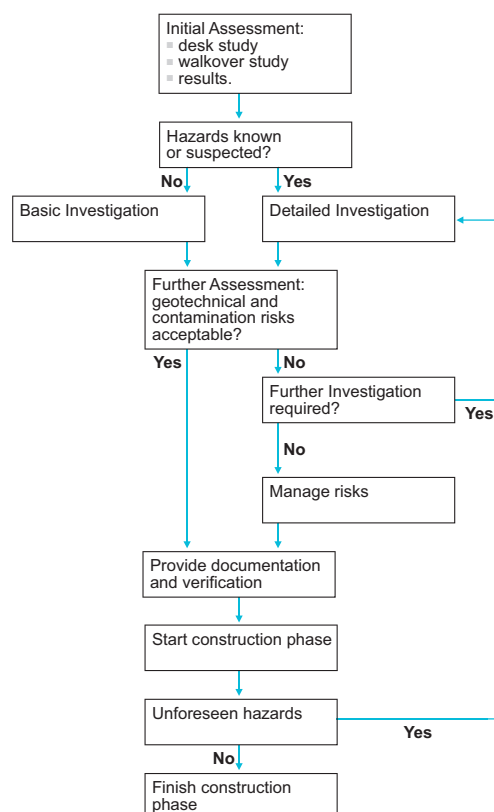

**Table 1:** Potential hazards and associated risks

Potential hazard	Associated risk
High water table or low-lying land	<ul style="list-style-type: none"> <li>■ flooding</li> <li>■ the effects from toxic or noxious materials which could be concentrated or transported by ground water.</li> </ul>
Mining (past, present and proposed)	<ul style="list-style-type: none"> <li>■ ground movement as a result of the type of mining and materials extracted</li> <li>■ ground gasses, including methane and carbon dioxide.</li> </ul>
Trees	<ul style="list-style-type: none"> <li>■ shrinkage and heave of clay soils</li> <li>■ physical damage caused by roots.</li> </ul>
Peat	<ul style="list-style-type: none"> <li>■ acid attack</li> <li>■ changes in volume due to variations in moisture content</li> <li>■ production of methane and carbon dioxide.</li> </ul>
Infill and made ground, including tipping	<ul style="list-style-type: none"> <li>■ release of gases which may be explosive or asphyxiating</li> <li>■ low bearing capacity causing excessive total and/or differential settlements</li> <li>■ consolidation characteristics which may result in subsidence, settlement and/or excessive tilt</li> <li>■ localised ground variability (laterally and with depth) which may result in subsidence, settlement and/or excessive tilt</li> <li>■ collapse compression or inundation settlement of non-cohesive fills which may result in subsidence, settlement and/or excessive tilt.</li> </ul>
Low bearing capacity ground	<ul style="list-style-type: none"> <li>■ settlement of foundations and substructures.</li> </ul>
Former buildings or structures	<ul style="list-style-type: none"> <li>■ underground obstructions producing variations in bearing capacity and settlement characteristics.</li> </ul>
Adjacent buildings	<ul style="list-style-type: none"> <li>■ effect on stability of both new and existing buildings.</li> </ul>
Drains, including land drains	<ul style="list-style-type: none"> <li>■ contamination, flooding, waterlogging and interruption of land drainage systems.</li> </ul>
Sulfates in ground or ground water	<ul style="list-style-type: none"> <li>■ expansive reaction</li> <li>■ chemical attack on concrete, mortar and bricks or blocks made with cement.</li> </ul>
Contamination	<ul style="list-style-type: none"> <li>■ from substances which may be carcinogenic, toxic, asphyxiating, corrosive, phytotoxic, combustive, explosive or radioactive.</li> </ul>
Solution features in chalk and limestone, including swallow holes	<ul style="list-style-type: none"> <li>■ underground cavities.</li> </ul>
Unstable ground subject to landslip	<ul style="list-style-type: none"> <li>■ ground movement.</li> </ul>
Seas, lakes and rivers adjacent to land	<ul style="list-style-type: none"> <li>■ erosion.</li> </ul>

### 4.1.2 Initial Assessment – desk study (all sites)

**A desk study of the site and the surrounding area, that covers key and existing site information, shall be undertaken by a suitable person and include investigation of soils, geology, surface water, ground water, current and historical uses.**

A desk study is the collection and examination of existing information obtained from a wide variety of sources. It should indicate potential hazards at an early stage and provide a basis for the investigation. Potential problems should be assessed according to the current and historical uses of the site and surrounding area, including those which may have been left by:

- industrial, commercial and agricultural uses, including storage
- mining
- quarrying
- landfilling and tipping.

Key information sources include:

- the Environment Agency or its equivalent – for example, coastal erosion, landfill sites, details of water abstraction
- the local authority – for example planning and environmental health
- British Geological Survey, maps and information
- Ordnance Survey, current and previous editions of plans and aerial photographs
- Coal Authority, mining reports – past, present and proposed mining
- utility companies
- county records offices, libraries, museums and local history sources
- soil survey maps
- the site vendor
- in-house information
- ongoing monitoring.



### 4.1.3 Initial Assessment – walkover survey (all sites)

**To assess ground conditions, a walkover survey of the site and the surrounding area shall be undertaken by a suitable person.**

A walkover survey is a direct inspection of the site and the surrounding area carried out in conjunction with the desk study. Indications of any potential hazards should provide a basis for the investigation. A photographic record of the site can help in the reporting of the walkover survey.

**Table 2:** Potential hazards

Source of information	Items to be taken into account
Topography	<ul style="list-style-type: none"> <li>■ abrupt changes in slope</li> <li>■ valley bottoms or depressions which may be soft or filled</li> <li>■ evidence of overburden on slopes</li> <li>■ excavations at the base of the slope</li> <li>■ signs of landslip, e.g. tilting trees, posts or walls</li> <li>■ signs of subsidence</li> <li>■ evidence of imported soil including local surface depressions, tipped material or rubbish, particularly if it is hot or has an odour.</li> </ul>
Soils and rocks	<ul style="list-style-type: none"> <li>■ the basic ground type</li> <li>■ evidence of peat, silt or other highly compressible material at or below the surface</li> <li>■ cracking or stickiness of the surface which may indicate a shrinkable sub-soil</li> <li>■ sudden changes in conditions, e.g. clay to chalk or soil to rock.</li> </ul>
Surface water and vegetation	<ul style="list-style-type: none"> <li>■ a high water table indicated, e.g. by waterlogged ground</li> <li>■ signs of flooding</li> <li>■ reeds or water-loving plants</li> <li>■ springs, ponds, wells, ditches or streams</li> <li>■ the source of any discoloured water.</li> </ul>
Vegetation	<ul style="list-style-type: none"> <li>■ vegetation which may indicate the nature of the soils</li> <li>■ sparse dead or dying vegetation</li> <li>■ type and condition of vegetation on land adjoining the site</li> <li>■ species, height and condition of the trees</li> <li>■ species, height, spread and condition of hedges and scrub on clay</li> <li>■ evidence of former trees, hedges or scrub on clay.</li> </ul>
Structural information	<ul style="list-style-type: none"> <li>■ damage to structures, e.g. cracking in buildings, on or around the site</li> <li>■ other evidence of movement, e.g. tilting or distortion</li> <li>■ any structures or services below ground.</li> </ul>
Local information	<ul style="list-style-type: none"> <li>■ local knowledge of the site, e.g. mining, refuse tipping or flooding</li> <li>■ local industrial history records indicating past and present uses of the site</li> <li>■ place names and street names that may give clues to previous site usage, e.g. Brickfield Cottage, Water Lane.</li> </ul>

### 4.1.4 Initial Assessment – results

**The results of the desk study and walkover survey shall be recorded and evaluated by a suitable person.**

Initial results should be evaluated for suspected hazards and the results recorded, and include the following as appropriate:

- site plans, including dates, previous and current uses, and proposed site layout
- geology of the site, including geological maps, previous site investigations and laboratory test results
- photographs, including aerial photographs, showing points of interest or concern (e.g. areas of ground instability), interpretation of aerial photographs, and dates of photographs
- list of sources of information consulted and copies of the information obtained.

### 4.1.5 Basic Investigation (sites where hazards are not identified or suspected) Also see: BS EN 1997-2

**Where hazards are not suspected, a Basic Investigation of the site, including geotechnical and contamination investigations, shall be carried out by a suitable person and recorded to the satisfaction of NHBC.**

The Basic Investigation aims to provide assurance for all sites, regardless of how free of hazards they may appear, and forms the minimum requirement for a site investigation.

The number and depth of trial pits should be located so they are representative of the site and will depend upon the:

- proposed development
- nature of the site
- inconsistency of the soil and geology across the site.

Trial pits should be located outside the proposed foundation area, and generally be a minimum of 3m deep. The distance from the edge of the foundation should not be less than the depth of the trial pit. Where trial pits do not provide sufficient information, boreholes will be necessary.

Basic geotechnical and contamination investigations should be conducted and include:

- physical tests, such as plasticity index tests, to support the results of the Initial Assessment
- a basic contamination investigation based on sampling and testing of soil taken from trial pits during the geotechnical investigation.

During the excavation of the trial pits, the use of sight and smell may help to identify certain contaminants.

If the Basic Investigation reveals the presence of geotechnical and/or contamination hazards, or has not addressed all of the original objectives, or where there is any doubt about the condition of the ground, further Detailed Investigation should be conducted.

### 4.1.6 Detailed Investigation (sites where hazards are identified or suspected)

**Where hazards are identified or suspected, a Detailed Investigation of the site shall be conducted under the supervision of a consultant or specialist acceptable to NHBC to determine and report on the nature and extent of the conditions.**

A Detailed Investigation should be carried out where hazards are identified or suspected:

- from the outset
- from the initial results of the desktop study and walkover survey, or
- from the Basic Investigation.

A consultant or specialist acceptable to NHBC should be appointed to:

- design and supervise the Detailed Investigation
- present all the factual data obtained from the Detailed Investigation.

In addition to the Basic Investigation, the Detailed Investigation should adopt a clearly defined, structured approach, gathering information which considers the:

- immediate site and the adjacent area
- possibility of future development in the vicinity of the site
- nature of the development
- complexity of the ground conditions
- extent of influence of the proposed foundations
- presence of soil gas (if there is any possibility a full gas investigation should be carried out and include flow measurements)
- surface water and ground water conditions, soils and geology, and site history.

The problems and liabilities which have to be managed in order to develop the site should be clearly communicated in the Detailed Investigation report.

Further investigation should be conducted if the Detailed Investigation has not satisfactorily addressed all of the original objectives.

### 4.1.7 Managing the risks (sites where hazards are found)

**Hazardous ground conditions shall be satisfactorily managed under the supervision of a consultant or specialist acceptable to NHBC. Items to be taken into account include:**

- a) design precautions
- b) remediation techniques
- c) a method statement and report.

The consultant or specialist should:

- identify any results which show that design precautions and/or remediation may be necessary
- conduct a risk assessment to determine appropriate design precautions and/or remedial treatment
- specify the options for remediating any contamination that may be present and provide a remediation method statement
- make recommendations for appropriate design precautions as necessary, including all underground services on the site and any ground improvement techniques
- ensure the works are appropriately supervised
- produce a remediation report.

The proposed solutions for dealing with geotechnical and/or contamination hazards should make due allowance for any constraints that apply, for example:

- factors associated with the site and surrounding area which could restrict the design precautions or remediation techniques should be identified
- local and statutory requirements should be met to avoid abortive works
- time constraints may influence the choice of solution, but do not alter the requirement for effective remediation.

#### Design precautions

Solutions for dealing with geotechnical hazards include:

- specialist foundations such as rafts, piling and ground beams
- ground improvement techniques such as vibro, dynamic compaction and surcharging.

#### Remediation techniques

Solutions for dealing with contamination hazards include:

- risk avoidance by changing the pathway or isolating the target, by adjusting the layout and/or by building protective measures into the construction
- engineering-based treatments that remove or isolate contaminants or modify the pathway by excavation, providing ground barriers or covering and capping
- process-based treatment to remove, modify, stabilise or destroy contaminants by physical, biological, chemical or thermal means.

#### Remediation method statement and report

The remediation method statement should detail the strategy for the site and include the:

- original risk assessment, identification of the remediation objectives and outline information for the method chosen
- remediation objectives for ground, ground water and soil gas
- working method for implementing remediation
- waste classification and methods for control and disposal
- proposed supervision and monitoring of remediation
- validation sampling and testing to be implemented.

The report should include the following information:

- photographic records, especially for work which will be buried (e.g. membranes)
- site diaries or drawings, environmental supervisor's site diary and independent witness statements where appropriate
- accurate surveys of the levels and position of all remediated areas
- a description of any remedial materials used
- details of soil movements and waste transfer notes
- results of post-remediation sampling (laboratory certificates should be provided in appendices)
- validation test results
- results of monitoring
- details of all consultations and meetings with statutory authorities.

### 4.1.8 Unforeseen hazards

**Where additional or unforeseen hazards arise during construction, the builder shall ensure investigation and management satisfactory to NHBC.**

Where additional or unforeseen hazards arise, specialist advice is required so that the hazard is properly investigated, managed and verified.

### 4.1.9 Documentation and verification

Documentation and verification shall be provided to to the satisfaction of NHBC demonstrate that the site is suitable for the proposed development. All relevant information, designs, specifications and reports shall be produced in a clearly understandable format and distributed to appropriate personnel.

Where the site is within an area susceptible to radon, it will be necessary to follow appropriate guidance in the building regulations and associated documents. The information detailed in Table 3 should be provided to NHBC.

**Table 3:** Information required by NHBC

Geotechnical hazards present:	Yes	No	Yes	No
Contamination hazards present:	Yes	Yes	No	No
Initial Assessment, Further Assessment and Basic Investigation	■	■	■	■
Detailed Investigation	■	■	■	
Proposals to manage geotechnical risks	■		■	
Proposals to manage contamination risks	■	■		
Verification evidence	■	■	■	■

Note

Evidence may still be required by NHBC to substantiate that contamination and hazards are not present on the site.

### 4.1.10 Guidance for investigations

*Also see: BS EN 1997-2*

Site investigations shall be undertaken in accordance with BS EN 1997-2 and recognised practice. Items to be taken into account include:

- investigation technique
- sampling
- testing.

#### Investigation technique

A site investigation normally comprises techniques which are classed as either indirect or direct.

Indirect investigations use geophysical techniques, including electromagnetic, resistivity, seismic, gravity and ground radar, to interpret ground conditions. Conducted from the surface, they measure variations in properties of the ground, both horizontally and vertically, to define subsurface conditions. Geophysical methods rely on contrasts in the physical properties, for example, between sand and gravel and rockhead. Contrast may also be provided by faulting, underground cables and pipelines or by cavities.

Direct investigation techniques involve intrusive activities to enable the retrieval and examination of the ground using trial pits, trenches, boreholes or probes.

Trial pits allow the detailed inspection, logging, sampling and in-situ testing of large volumes of natural soil or fill and the assessment of ground water conditions. Trenches are extended trial pits, or linked trial pits, which are excavated where greater exposure of the ground conditions is required. Trial pits and trenches should be positioned where they will not affect future foundations.

Boreholes are typically formed using the following techniques:

<b>Light cable percussion drilling</b>	A shell and auger rig – typically used in the UK to drill boreholes in soils and weak rocks.
<b>Continuous flight auger</b>	Exploratory boreholes may be drilled in soils by mechanical continuous flight augers of various sizes. Hollow stem methods are typically employed where sample retrieval is required.
<b>Rotary drilling</b>	Either open-hole drilling or rotary coring, is used to investigate rock and sometimes stiff soils, such as boulder clay.
<b>Probing techniques</b>	Used to analyse the relative density of soils and for environmental sampling and monitoring (such as chemical and physical testing of gases, liquids and solids).

## Sampling

The number and type of samples taken should be:

- appropriate for the results of the desk study, the walkover survey and the site investigation
- appropriate for the range of ground materials encountered and the proposed development
- taken, stored and transported so that they avoid cross-contamination.

Samples are used to enable soil and rock descriptions to be made and to provide material for physical and chemical testing.

'Undisturbed' soil and rock samples undergo minimal disturbance, so provide a more reliable indication of the physical soil properties than 'disturbed' samples.

Ground water should be collected from appropriately designed monitoring wells which should be screened and sealed to ensure that the relevant stratum is being monitored.

Gas sampling should be carried out from appropriately designed monitoring wells, boreholes or window sampling holes are typically used. Identification of the probable source and the measurement of gas flow are important for risk assessments.

## Testing

Testing may be undertaken in-situ, or in a laboratory.

A wide variety of in-situ tests can be used to support the results of direct testing. These range from basic tests undertaken by geologists or engineers using simple hand-held devices or portable test kits to methods that require specialist personnel and equipment.

Testing laboratories should participate in quality assurance programmes and be accredited for relevant tests by bodies such as UKAS and MCERTS. Physical tests on soil and rock materials are carried out to provide the following information on ground:

- strength
- relative density
- deformation
- settlement
- consolidation characteristics
- permeability.

Chemical tests on soils, rocks, ground water and gases can be carried out to provide an indication of potential contamination on the site.

### 4.1.11 Further information

- BRE: Report BR211 – 'Radon: Guidance on protective measures for new dwellings'
- Report BR212 – 'Construction of new buildings on gas-contaminated land'
- Report BR376 – 'Radon: guidance on protective measures for new dwellings in Scotland' Report BR413 – 'Radon: guidance on protective measures for new dwellings in Northern Ireland'
- Report BR414 – 'Protective measures for housing on gas contaminated land'
- Digest 383 – 'Site investigation for low-rise buildings: Soil description'
- BS 10175 – 'Investigation of potentially contaminated sites'
- BS EN ISO 14688 – 'Geotechnical investigation and testing. Identification and classification of soil: Part 1. Identification and description. Part 2. Principles for a classification'
- BS EN ISO 22476 – 'Geotechnical investigation and testing. Sampling methods and groundwater measurements. Part 1. Technical principles for execution'
- BS 8485 – 'Code of practice for the characterization and remediation of ground gas in affected development'
- C665 – 'Assessing risks posed by hazardous ground gasses to buildings'
- Special publications 101 – 112 – 'Remedial treatment for contaminated land'
- DCLG and its predecessor departments
- Approved Documents A and C – 'Structures and site preparation and resistance to contaminants and moisture'
- DEFRA and its predecessor departments
- CLAN 02/05 'Soil guideline values and the determination of land as contaminated land under Part 2A'
- Circular 01/2006 Environmental Protection Act 1990: Part 2A Contaminated Land
- Department of the Environment Industry Profiles – 'Information on the processes, materials and wastes associated with individual industries'
- Department of the Environment – Waste Management Paper No 27 – 'Landfill Gas: A technical memorandum on the monitoring and control of landfill gas'
- CLR11 'Model procedures for the management of land contamination'
- CLEA (Contaminated Land Exposure Assessment) guidance and software Science Reports SR 1,2,3 and 7
- 'Guidance for the safe development of housing on land affected by contamination'.

# Building near trees

## CHAPTER 4.2

This chapter gives guidance on meeting the Technical Requirements when building near trees, hedgerows and shrubs, particularly in shrinkable soils.

4.2.1	Compliance	01
4.2.2	Provision of information	01
4.2.3	Building near trees	02
4.2.4	The effects of trees on shrinkable soils	03
4.2.5	Foundations in all soil types	06
4.2.6	Excavation of foundations	06
4.2.7	Foundations in shrinkable soils	06
4.2.8	Design and construction of foundations in shrinkable soils	08
4.2.9	Foundation depths for specific conditions in shrinkable soils	09
4.2.10	Heave precautions	10
4.2.11	New drainage	13
4.2.12	Foundation depth charts	13
4.2.13	Foundation depth tables	16
4.2.14	Example	22
4.2.15	Further information	24



### Introduction

The combination of shrinkable soils and trees, hedgerows or shrubs represents a hazard to structures that requires special consideration. Trees, hedgerows and shrubs take moisture from the ground and, in cohesive soils such as clay, this can cause significant volume changes resulting in ground movement. This has the potential to affect foundations and damage the supported structure. In order to minimise this risk, foundations should be designed to accommodate the movement or be taken to a depth where the likelihood of damaging movement is low.

This chapter gives guidance for common foundation types to deal with the hazard and includes suitable foundation depths which have been established from field data, research, NHBC data and practical experience. The depths are not those at which root activity, desiccation and ground movement are non-existent, but they are intended to provide an acceptable level of risk. However, if significant quantities of roots are unexpectedly encountered in the base of the trench, the excavation may need to be deepened.

The interaction between trees, soil and buildings is dependent on many factors and is inherently complex. The relationship becomes less predictable as factors combine to produce extreme conditions. These are signified by the need for deeper foundations. Depths greater than 2.5m indicate that conditions exist where prescriptive guidance is less reliable.

The services of a specialist arboriculturalist may be helpful for the identification of the type and condition of trees that may affect building work. This includes trees both on and adjacent to the site.

Consideration has been given to the potential effects of climate change in the guidance provided.

The following situations are beyond the scope of the guidance in this chapter and will require a site-specific assessment by an engineer (see Technical Requirement R5):

- Foundations deeper than 2.5m within the influence of trees.
- Ground with a slope of greater than 1 in 7 (approximately 8°) and man-made slopes such as embankments and cuttings.
- Underpinning.

#### 4.2.1 Compliance

*Also see: Chapter 2.1*

**When building near trees, hedgerows or shrubs, all foundations shall comply with the Technical Requirements.**

Foundations near trees, hedgerows or shrubs that comply with the guidance in this chapter will generally be acceptable.

#### 4.2.2 Provision of information

**Designs and specifications shall be produced in a clearly understandable format, include all relevant information and be distributed to appropriate personnel.**

The site plan should show the trees and hedgerows that affect the ground and works, as well as the type, depth and dimensions of the foundations that fall within their influence. Where trees or hedgerows are either not shown or are in different positions and shrinkable soil is identified, it may be necessary to adjust the foundation depths on site.

All necessary dimensions and levels should be indicated and relate to at least one benchmark and reference points on the site.

Details should be provided with respect to:

- |   |   |
|---|---|
| ■ technical method statements   | ■ original and final ground levels  |
| ■ critical sequences of construction  | ■ planting schedules  |
| ■ site layout   | ■ dimensions, type and depth of foundations   |
| ■ site investigation  | ■ locations and detailing of steps in foundations, movement and construction joints, ducts and services passing through the foundations |
| ■ soil volume change potential  | ■ location of services  |
| ■ survey, including location and height of trees and hedgerows affecting the site | ■ design of drainage systems.   |
| ■ tree species (including existing, removed and proposed) using English names     |   |

### 4.2.3 Building near trees

Also see: *Technical Requirements R5 and BS 5837*

**When building near trees, hedgerows or shrubs, the designs shall take account of:**

- a) physical growth of young trees
- b) protection of remaining trees and hedgerows
- c) removal of existing trees and hedgerows.

Before the site is cleared, a survey is required to record the location, heights and species of trees, hedgerows and shrubs on and adjacent to the site, which may affect the proposed development.

If the location of previously removed vegetation is not known, local enquiries and reference to aerial photographs should be carried out. Alternatively, the design should assume the worst conditions, or an engineer consulted to undertake a site-specific design based on all relevant information and in accordance with Technical Requirement R5.

Where root growth is noted within shrinkable soil and where records are not available, an engineer should be consulted to assess whether volume change is likely.

#### Physical growth of young trees

Damage to foundations resulting from the growth of trees and roots should be avoided by locating structures and services at a safe distance. Where this cannot be achieved, precautions which allow for future growth should be taken which include:

- reinforcing foundations to resist lateral forces
- bridging walls or structural slabs over the roots, allowing sufficient clearance or reinforcing to avoid cracking
- laying paving and other surfaces on a flexible base to allow for some movement.

#### Protection of remaining trees and hedgerows

Roots often extend to distances in excess of the height of the tree, the majority are within 600mm of the surface and project radially. All parts of the system are easily susceptible to damage which may not regenerate and which can affect the stability of the tree.

This can be caused by:

- stripping topsoil too close to trees
- excavating trenches for foundations and services too close to trees
- raising soil levels adjacent to trees, particularly where non-granular materials are used
- the compaction of soil around trees by heavy plant
- the storage of heavy materials around trees
- covering the rooting area with impervious surfaces.

Trees should be protected from damage by:

- a fence or barrier. The fence or barrier should extend around a single trunk equivalent to a circle of radius 12 times the trunk diameter measured 1.5m above ground level.
- ensuring services are not routed close to trees or, where this is impractical, are installed in such a way as to minimise root damage.

The shape of this area may change depending on specific factors such as local drainage, soil type, age and species of the tree. An arboriculturist may be required to assess these factors

#### Removal of existing trees and hedgerows

Statutory Requirements, planning conditions, conservation area restrictions or tree preservation orders may result in protected trees and hedgerows being retained. The local planning authority should be consulted.

Dead trees and hedgerows should be removed. Unstable trees should be made steady or felled. If necessary, specialist advice should be obtained from a registered arboriculturalist.



### 4.2.4 The effects of trees on shrinkable soils

Also see: *Arboricultural Advisory and Information Service, Arboricultural Association, BRE Digest 240 and local geological survey maps*

**Foundations shall be designed to make allowance for the effect of trees, hedgerows and shrubs on shrinkable soils. Items to be taken into account include:**

- soil classification, shrinkage and heave
- water demand, tree heights and zone of influence of trees
- climate.

#### Soil classification, shrinkage and heave

Shrinkable soils, that are widely distributed throughout the UK, often change volume as moisture content fluctuates seasonally and as a result of factors, including the action of tree roots. The resulting shrinkage or swelling can cause subsidence or heave damage to foundations, the structures they support and services.

The following definitions are used to classify soil properties:

<b>Shrinkable soils</b>	Over 35% fine particles and a Modified Plasticity Index of 10% or greater.
<b>Fine particles</b>	Nominal diameter less than 60µm, i.e. clay and silt particles.
<b>Plasticity Index (Ip)</b>	A measure of volume change potential determined by Atterberg Limits tests. These tests are carried out on the fine particles and any medium and fine sand particles. Soil particles with a nominal diameter greater than 425µm are removed by sieving beforehand and the smaller particles analysed. This is a requirement of BS 1377 which specifies the test procedure.
<b>Modified Plasticity Index (I'p)</b>	Defined as the Ip of the soil multiplied by the percentage of particles less than 425µm. $I'p = \frac{Ip \times \% \text{ less than } 425\mu\text{m}}{100\%}$

**Table 1:** Modified Plasticity Index related to volume change potential

Modified Plasticity Index	Volume change potential
40% and greater	High
20% to less than 40%	Medium
10% to less than 20%	Low

Alternatively, the Plasticity Index may be used without modification. For pure clays and other soils with 100% of particles less than 425µm, the result will be the same. However, for mixed soils such as glacial tills, use of the Modified Plasticity Index may result in a more economic design.

The volume change potential should be established from site investigation and reliable local knowledge of the geology. Sufficient samples should be taken to provide confidence that the results are representative. High volume change potential should be assumed if the volume change potential is unknown.

#### Water demand, tree heights and lateral zone of tree influence

Water demand varies according to tree species and size. Water demand categories of common tree species are given in the table below.

Where the species of a tree has not been identified, high water demand should be assumed.

Where the species of a tree has been identified but is not listed, the assumptions about water demand as listed in Table 2 may be made for broad-leafed trees:

**Table 2:** Water demand of broad-leaf trees by species

Tree species	Water demand
All elms, eucalyptus, hawthorn, oaks, poplars and willows	High water demand
All others	Moderate water demand

Table 3 shows the water demand categories and the average mature heights to which healthy trees of the species may be expected to grow in favourable ground and environmental conditions. This information:

- should be used for trees that are to remain or are scheduled to be planted
- may be used even when actual heights are greater.

**Table 3:** Water demand of tree species in relation to their height

High water demand species	Mature height (m)	Moderate water demand species	Mature height (m)	Low water demand species	Mature height (m)
<b>Broad-leaved trees:</b>					
English elm	24	Acacia (False)	18	Birch	14
Wheatley elm	22	Alder	18	Elder	10
Wych elm	18	Apple	10	Fig	8
Eucalyptus	18	Ash	23	Hazel	8
Hawthorn	10	Bay laurel	10	Holly	12
English oak	20	Beech	20	Honey locust	14
Holm oak	16	Blackthorn	8	Hornbeam	17
Red oak	24	Japanese cherry	9	Laburnum	12
Turkey oak	24	Laurel cherry	8	Magnolia	9
Hybrid black poplar	28	Orchard cherry	12	Mulberry	9
Lombardy poplar	25	Wild cherry	17	Tulip tree	20
White poplar	15	Horse chestnut	20		
Crack willow	24	Sweet chestnut	24		
Weeping willow	16	Lime	22		
White willow	24	Japanese maple	8		
		Norway maple	18		
		Mountain ash	11		
		Pear	12		
		Plane	26		
		Plum	10		
		Sycamore	22		
		Tree of heaven	20		
		Walnut	18		
		Whitebeam	12		
<b>Coniferous trees:</b>					
Lawson's cypress	18	Cedar	20		
Leyland cypress	20	Douglas fir	20		
Monterey cypress	20	Larch	20		
		Monkey puzzle	18		
		Pine	20		
		Spruce	18		
		Wellingtonia	30		
		Yew	12		

Tree identification can be assisted by reference to a tree recognition book. Information may be obtained from suitable alternative authoritative sources for trees not listed in this chapter.

When the species is known but the subspecies is not, the greatest height listed for the species should be assumed.

Where hedgerows contain trees, their effect should be assessed separately and the height of the species likely to have the greatest effect should be used.

**Table 3a:** Guidance for factors affecting the mature height and water demand of trees

Influencing factor	Guidance
Heavy crown reduction or pollarding (previously or planned)	The mature height should be used, or a registered arboriculturalist should be consulted to undertake a site-specific assessment.
Removal of trees (previously or planned)	The water demand of a semi-mature tree may be equal to that of a mature tree, though for a sapling or young tree will be significantly less.

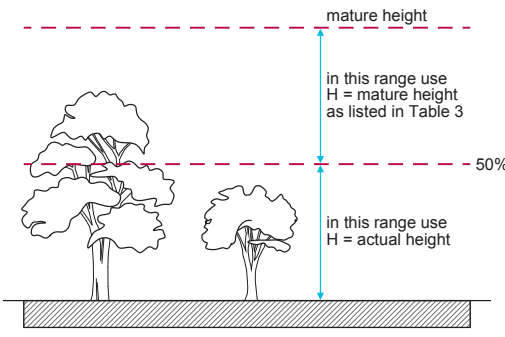

Height H should be determined in accordance with this diagram when:

- deriving foundation depths when trees have been removed, based on tree height at the time of removal
- checking the appropriate level from which depths should be measured when trees remain and the ground level is increased, based on tree height at time of construction relative to original ground level, or
- determining if heave precautions are to be provided, based on tree height at time of construction.

**Table 3b:** Zone of influence (lateral extent) of trees.

Water demand	Zone of influence
High	1.25 x mature height
Moderate	0.75 x mature height
Low	0.5 x mature height

**Climate**

High rainfall reduces moisture deficits caused by trees and hedgerows, while cool, damp weather reduces the rate of water loss from trees thus reducing the risk of soil movement.

The driest and hottest areas in the UK generally exist in southeast England; therefore, the greatest risk occurs in that area and diminishes with distance north and west. A 50mm decrease can be made to the foundation depth determined in accordance with this chapter for every 50 miles distance north and west of London. Where it is unclear which zone applies, the lower reduction value should be used.

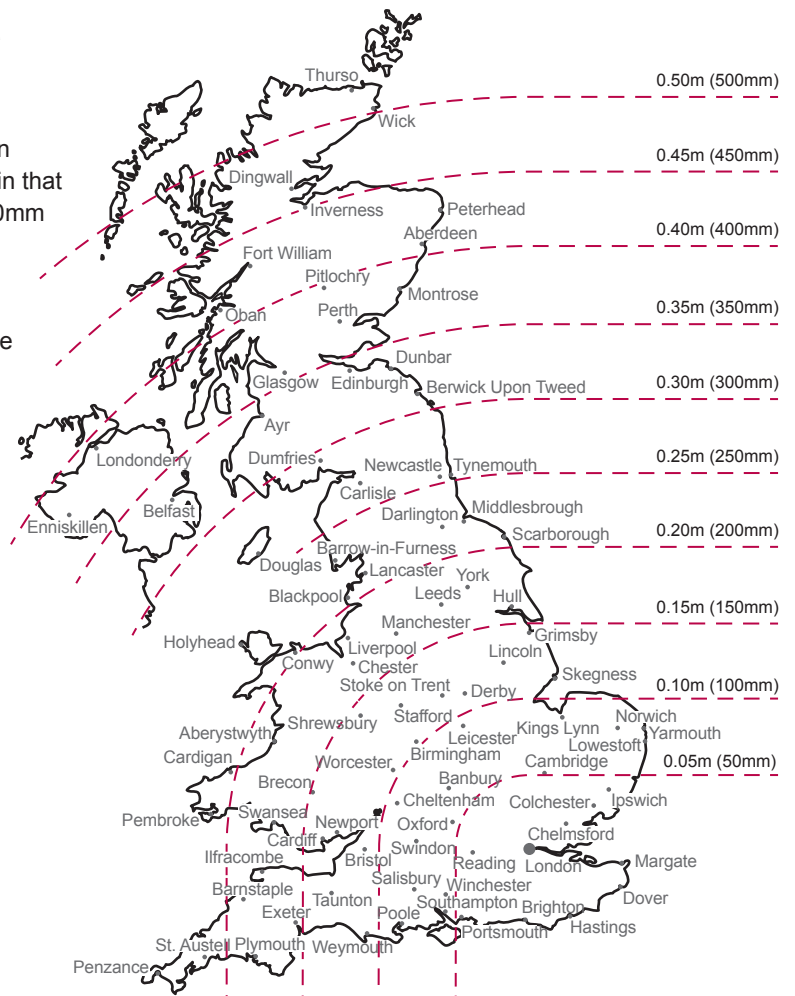

### 4.2.5 Foundations in all soil types

**Foundations in all soil types shall be appropriately designed and constructed to transmit loads to the ground safely and without excessive movement.**

Different foundation types should not be used to support the same structure unless the foundation and superstructure design are undertaken by an engineer.

Freestanding masonry walls should be constructed on foundations in accordance with this chapter or designed to accommodate potential ground movement, for example, by careful use of movement joints and reinforcement.

### 4.2.6 Excavation of foundations

*Also see: Chapter 4.1, 4.3, 4.4, 4.5 and Technical Requirement R5*

**Excavation of foundations shall take account of the design and be suitable to receive concrete.**

Where trench bottoms become excessively dried or softened due to rain or ground water, the excavation should be re-bottomed prior to concreting.

Foundation depths should be measured on the centre line of the excavation and from ground level determined from Clause 4.2.9.

Some root activity may be expected below the depths determined in accordance with this guidance. However, if significant quantities of roots are unexpectedly encountered in the base of the trench, an engineer should be consulted to determine if the excavation should be deepened.

### 4.2.7 Foundations in shrinkable soils

*Also see: NHBC Foundation Depth Calculator App. [www.nhbc.co.uk/apps](http://www.nhbc.co.uk/apps)*

**Foundations shall be capable of accommodating the effects of trees, shrubs and hedgerows on shrinkable soils without excessive movement. Items to be taken into account include:**

- a) foundation type
- b) distance between tree and foundation
- c) method of assessment of foundation depths
- d) foundation depths related to the zone of influence of new tree planting
- e) foundation depths related to new shrub planting.

Landscape and foundation designs should be compatible, and planting schedules produced by a qualified landscape architect or other suitably qualified person and agreed with the local planning authority before work commences on site.

#### Foundation type

Foundations to all permanent structures, including garages, porches and conservatories, should take account of the effects of soil desiccation. Foundation types that are acceptable in shrinkable soils include strip, trench fill, pier and beam, pile and beam, and raft, providing they:

- are capable of supporting the applied loads without undue settlement
- include suitable heave precautions.

Variations to the foundation depths derived from this chapter may be permitted where:

- it is necessary to take account of local ground conditions
- designed in accordance with Technical Requirement R5.
- other foundation depths are traditionally acceptable

Root barriers are not an acceptable alternative to the guidance given.

#### Distance between tree and foundation

The distance (D) between the centre of the trunk and the nearest face of the foundation should be used to derive the foundation depths.

$D = 2m$  where trees which have been, or are to be, removed from within 2m of the face of the proposed foundation are less than 50% of the mature height as given in Table 3. This is to avoid a situation where, for example, a 'sapling' removed from the foundation line would otherwise require an unnecessarily deep foundation since the D/H value would always be zero, regardless of the height H of the tree.

### Method of assessment of foundation depths

Foundation depths should be determined according to the guidance provided in this document. If in doubt, assume the worst conditions or consult an engineer. Foundations deeper than 2.5m should be designed by an engineer in accordance with Technical Requirement R5.

One of the following methods may be used to assess the foundation depth where foundations are in the zone of influence of existing or proposed trees.

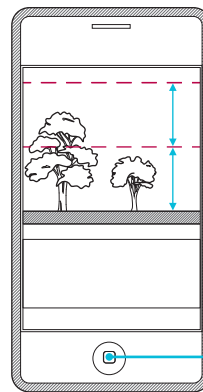

Foundation Depth Calculator App.  
www.nhbc.co.uk/apps

Method	Taking account of	Comments
Design in accordance with this chapter to a depth derived from the charts in Clause 4.2.12, tables in Clause 4.2.13 or the Foundation Depth Calculator App	<ul style="list-style-type: none"> <li>■ site investigation</li> <li>■ soil volume change potential</li> <li>■ water demand of the tree</li> <li>■ appropriate tree height (H)</li> <li>■ distance (D) of the tree(s) from the foundations</li> <li>■ geographical location of the site north and west of London</li> <li>■ appropriate heave precautions.</li> </ul>	The most onerous conditions should be assumed in the absence of derived information.
Design by an engineer in accordance with Technical Requirement R5	<ul style="list-style-type: none"> <li>■ the recommendations of this chapter</li> <li>■ site investigation</li> <li>■ advice, when necessary, from a registered arboriculturalist or other competent person whose qualifications are acceptable to NHBC.</li> </ul>	When this method is used and it results in foundation depths or other details less onerous than those derived from this chapter, the design should be submitted to NHBC for approval prior to work commencing on site.

### Foundation depths related to the zone of influence of new tree planting

Foundation depths relating to the zone of influence of proposed tree planting should be in accordance with any of the following:

- Foundation depth charts in Clause 4.2.12.
- The Foundation Depth Calculator App.
- Tables in Clause 4.2.13.

Minimum foundation depths outside of the zone of influence of trees can be determined from Tables 4 and 5.

**Table 4:** Minimum foundation depths

Volume change potential	A) Minimum foundation depth (m) (allowing for restricted new planting)	B) Minimum foundation depth (m) (where planting is outside the zone of influence of trees)
High	1.50	1.0
Medium	1.25	0.9
Low	1.0	0.75

**Table 5:** Where foundation depths are in accordance with column A or column B in Table 4, tree planting should be restricted to:

Water demand	No tree planting zone for column A in Table 4	No tree planting zone / zone of influence for column B in Table 4
High	1.0 x mature height	1.25 x mature height
Moderate	0.5 x mature height	0.75 x mature height
Low	0.2 x mature height	0.50 x mature height

### Foundation depths related to new shrub planting

Shrubs have considerable potential to cause changes in soil moisture content. The foundation design should consider shrub planting in accordance with Table 6.

**Table 6:** Shrub planting

Volume change potential	A) Minimum foundation depth (m)	B) Minimum foundation depth (m)
High	1.50	1.0
Medium	1.25	0.9
Low	1.0	0.75

The foundation design should consider shrub planting as follows:

<b>Shrubs that have a maximum mature height of 1.8m</b>	Use foundation depth from column <b>B</b> .
<b>Climbing shrubs which require wall support and have a maximum mature height of 5.0m</b>	Use foundation depth from column <b>B</b> .
<b>Pyracantha and cotoneaster whose mature height exceeds 1.8m</b>	Use foundation depth from column <b>B</b> and plant at least 1.0 x mature height from foundation, or use foundation depth from column <b>A</b> and plant at least 0.5 x mature height from foundation.
<b>All others</b>	Use foundation depth from column <b>B</b> and plant at least 0.75 x mature height from foundation, or use foundation depth from column <b>A</b> with no restriction on minimum distance from foundation.

#### 4.2.8 Design and construction of foundations in shrinkable soils

*Also see: Chapters 4.3, 4.4 and Technical Requirement R5*

**Foundations in shrinkable soils shall be appropriately designed and constructed.**

Reference should be made to Clause 4.2.10 to establish the precautions necessary to cater for potential heave.

The following will only be acceptable if they are designed by an engineer and account for all potential movement of the soil on the foundations and substructure:

- Trench fill foundations deeper than 2.5m.
- Pier and beam foundations.
- Pile and beam foundations.
- Rafts.

##### Trench fill foundations

If trench fill foundations are deeper than 2.5m:

- the instability of the trench sides can lead to serious construction difficulties
- the design should take account of soil desiccation and the associated arboricultural advice
- additional heave precautions may be necessary to cater for lateral and shear forces acting on large vertical areas of foundation
- concrete overspill or overbreak in excavations should be avoided in order to reduce the possibility of additional vertical forces being transmitted to the foundation
- compressible material should be correctly placed to avoid excessive heave forces being applied to the foundations
- construction joints need to be detailed to account for increased lateral forces.

##### Pier and beam foundations

Pier depths not exceeding 2.5m depth may be derived from Clause 4.2.7. Pier depths greater than 2.5m require site specific assessment.

##### Pile and beam foundations

When selecting and designing pile and ground beam foundations, piles should be:

- designed with an adequate factor of safety to resist uplift forces on the shaft due to heave.
- reinforced for the length of the member governed by the heave design.

Sufficient anchorage should be provided below the depth of desiccated soil. Slip liners may be used to reduce uplift but the amount of reduction is small, as friction between materials cannot be eliminated.

Bored, cast-in-place piles are well suited to counteracting heave. Most types have a straight-sided shaft, while some are produced with a contoured shaft to increase load capacity. The design should allow for the enhanced tensile forces in these piles.

Driven piles are less well suited to counteracting heave and are difficult to install in stiff desiccated clay without excessive noise and vibration. The joint design of these piles should be capable of transmitting tensile heave forces.

Ground beams should be designed to account for the upward forces acting on their underside and transmitted from the compressible material or void former prior to collapse, and in accordance with the manufacturer's recommendations.

### Raft foundations

Raft foundations in shrinkable soils will only be acceptable where all of the following apply:

- design is by an engineer in accordance with Technical Requirement R5
- NHBC is satisfied that the raft is sufficiently stiff to resist differential movements
- NHBC is satisfied that the raft is founded on granular infill placed and fully compacted in layers and in accordance with the engineer's specification. Where required by NHBC, site inspections are to be undertaken by the engineer to verify suitable compaction of the fill
- the raft is generally rectangular in plan with a side ratio of not more than 2:1
- foundation depth is derived in accordance with Clause 4.2.7, and is less than 2.5m.

### 4.2.9 Foundation depths for specific conditions in shrinkable soils

Foundations in shrinkable soils shall be designed to transmit loads to the ground safely and without excessive movement. Items to be taken into account include:

- a) strip and trench fill foundations in non-shrinkable soils overlying shrinkable soil
- b) measurement of foundation depths
- c) granular infill beneath raft foundations in shrinkable soils
- d) steps in foundations.

#### Strip and trench fill foundations in non-shrinkable soils overlying shrinkable soil

Non shrinkable soils such as sands and gravels may overlie shrinkable soil. Foundations may be constructed on overlying non-shrinkable soil if all the following are satisfied:

- Conditions of Chapter 4.3 'Strip and trench fill foundations' are met.
- Consistent soil conditions exist across each plot and this is confirmed by the site investigation.
- Depth of the non-shrinkable soil is greater than  $\frac{3}{4}$  foundation depth X, where X is the foundation depth determined using charts in Clause 4.2.12, tables in Clause 4.2.13 or the Foundation Depth Calculator App, assuming all the soil is shrinkable.
- The thickness T of non-shrinkable soil below the foundation is equal to, or more than, the width of the foundation B.
- Proposals are submitted to, and approved by, NHBC prior to work commencing on site.

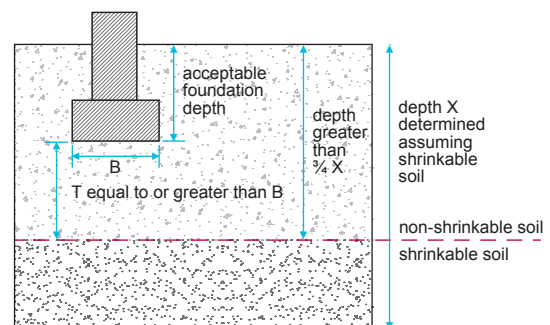

Where any of the above are not met foundation depths should be determined as for shrinkable soil.

#### Measurement of foundation depths

Where ground levels are to remain unaltered, foundation depths should be measured from original ground level.

Measurement of foundation depths where ground levels are reduced or increased, either in the recent past or during construction, should be as shown in figures 1, 2 and 3.

**Figure 1:** Levels from which foundation depths are measured where trees or hedgerows are to remain

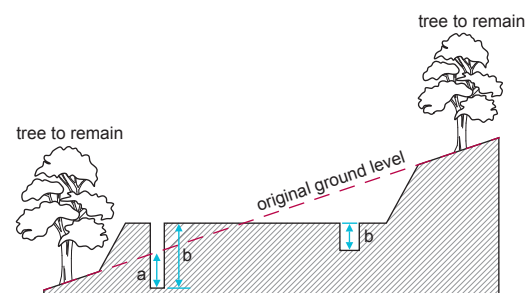

Use the lower of:  
 a) foundation depth based on appropriate tree height (see Table 3a)  
 b) foundation depth based on mature height of tree.

**Figure 2:** Levels from which foundation depths are measured where trees or hedgerows are removed

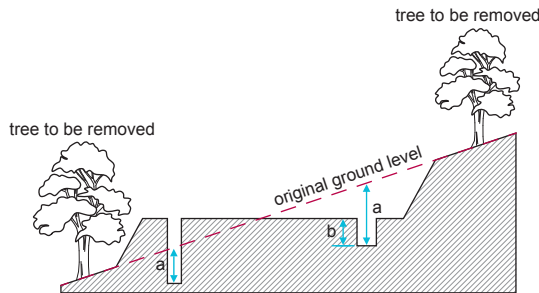

Use the lower of:  
 a) foundation depth based on appropriate tree height (see Table 3a)  
 b) minimum foundation depth (see Table 4 column B).

**Figure 3:** Levels from which foundation depths are measured where trees or hedgerows are proposed

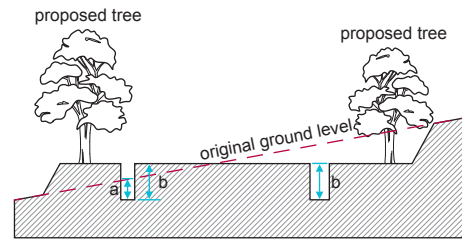

Use the lower of:  
 a) minimum foundation depth (see Table 4 column B)  
 b) foundation depth based on mature height of tree.

### Granular infill beneath raft foundations in shrinkable soils

Granular infill should be placed beneath raft foundations on shrinkable soils as shown below.

Infill should:

- be at least 50% of the foundation depth and not more than 1.25m deep (measured from ground level determined in accordance with 4.2.9b)
- extend beyond the edge of the foundation by a distance equal to its natural angle of repose, plus 0.5m.

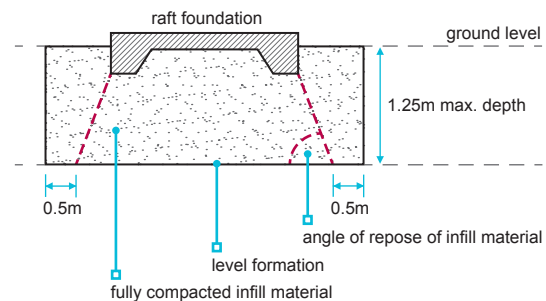

### Steps in foundations

On sloping ground, foundation trenches can be gradually stepped so that the required foundation depth is reasonably uniform below ground level.

Where foundations are to be stepped to take account of the influence of trees, hedgerows and shrubs, they should be stepped gradually, with no step exceeding 0.5m.

#### 4.2.10 Heave precautions

Also see: Chapter 2.1 and BS 5837

**Foundations, substructures and services shall be suitably designed and detailed to prevent excessive movement due to heave. Heave precautions shall be incorporated into foundations and substructures in accordance with the design. Items to be taken into account include:**

- |                                      |                            |
|--------------------------------------|----------------------------|
| a) potential for ground movement     | e) other foundation types  |
| b) minimum void dimensions           | f) suspended ground floors |
| c) proprietary heave materials       | g) paths and driveways.    |
| d) heave precautions for foundations |                            |

Where foundations and substructure may be subject to heave, they should be protected by voids, void formers or compressible materials.

Where proprietary materials are used, the design of foundations and substructure should take into account the upward force transmitted through the compressible material or void former prior to collapse (refer to manufacturer's data).

This section provides guidance on heave precautions for common building elements when located within the influence of trees which are to remain or be removed, including:

- trench fill foundations
- pier and beam foundations
- pile and beam foundations
- other foundation types
- paths and driveways
- new drainage.



## Technical Disclaimer

The NHBC Standards are produced by NHBC as guidance solely for our builder customers as to how to interpret the technical requirements in relation to the warranty cover provided by NHBC under its Buildmark, Buildmark Choice, Buildmark Link, Buildmark Solo, Buildmark Connect or any similar product from time to time. It has not been created or intended for distribution or use outside of that purpose. The information contained in the NHBC Standards do not constitute advice and is not to be relied upon by any third party. Nothing in the NHBC Standards is intended to, nor should it be taken to, create any legal or contractual relationship. Any third party who chooses to rely upon the information contained in the NHBC Standards shall do so entirely at their own risk and NHBC accepts no duty of care or liability, however caused, in connection with its use or reliance by any third party.

NHBC is authorised by the Prudential Regulation Authority and regulated by the Financial Conduct Authority and the Prudential Regulation Authority.

NHBC is registered in England under company number 00320784. NHBC's registered address is NHBC House, Davy Avenue, Knowlhill, Milton Keynes, Bucks MK5 8FP.

NHBC Standards 2018 have been printed on material which is produced from sustainable forests and is fully recyclable and biodegradable, ECF (elemental chlorine free) and is made to ISO 14001 Environmental Certification.



NHBC, NHBC House,  
Davy Avenue, Knowlhill,  
Milton Keynes,  
Bucks MK5 8FP  
Tel: 0344 633 1000  
Fax: 01908 747255  
[www.nhbc.co.uk](http://www.nhbc.co.uk)

